

# VOLTECH INSTRUMENTS

## AT EDITOR dotNET User Manual

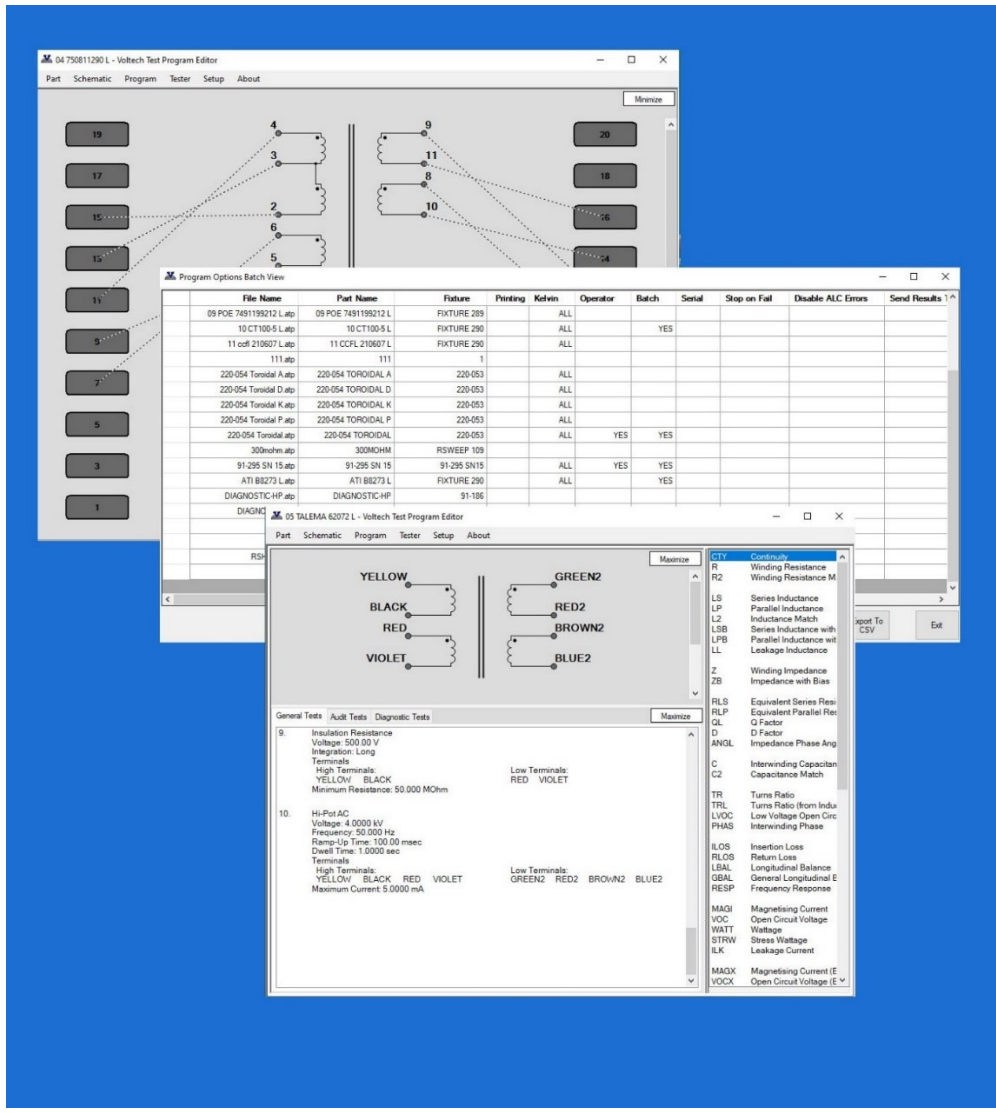

---

# **AT EDITOR dotNET**

[sales@voltech.com](mailto:sales@voltech.com)

[www.voltech.com](http://www.voltech.com)

© Voltech Instruments All rights reserved.

No part of this publication may be produced, stored in a retrieval system, or transmitted in any form, or by means, electronic, mechanical photocopying, recording or otherwise without prior written permission of Voltech.

**98-125 Issue 4 – 22 MAY 2024**

# Table of Contents

<b>1. Introduction .....</b>	<b>7</b>
1.1. AT Editor dotNET - New Features .....	7
1.1.1. Auto Programming .....	8
1.1.2. Program Options - Batch View .....	10
1.1.3. Test List Editing .....	11
1.1.4. Resizable Windows .....	11
1.1.5. Individual Test Run Time (AT5600 only) .....	12
1.1.6. Save Program and Result As PDF .....	13
1.1.7. History of AT Editor Versions .....	14
<b>2. AT Series Editor Software .....</b>	<b>15</b>
2.1. Installing the Editor Software .....	15
2.1.1. Computer Requirements .....	15
2.1.2. Installing the USB Drivers (AT5600 only) .....	15
2.1.3. Installing the main application .....	16
2.2. Starting for the first time .....	17
2.2.1. Running the software .....	17
2.2.2. Communications Configuration .....	17
2.3. Creating the Schematic .....	18
2.3.1. Adding a Transformer Winding .....	19
2.3.2. Connecting the Winding Terminals to Nodes .....	20
2.3.3. Deleting a Winding .....	21
2.3.4. Renaming a Terminal .....	22
2.3.5. Adding a Terminal to an Existing Winding .....	23
2.3.6. Deleting a Terminal from an Existing Winding .....	24
2.3.7. Adding a Core Connection .....	24
2.3.8. Deleting a Core Connection .....	24
2.3.9. Adding a Screen Connection .....	25
2.3.10. Deleting a Screen Connection .....	25
2.4. Creating the Program .....	26
2.4.1. Setting the Program Options .....	27
2.4.1.1. Results Printing .....	28
2.4.1.2. Kelvin Pre-Check .....	29
2.4.1.3. Operator Numbering .....	32
2.4.1.4. Batch Numbering .....	32
2.4.1.5. Serial Numbering .....	32
2.4.1.6. Send Results to Server .....	32
2.4.1.7. Send Retry Results to Server .....	32
2.4.1.8. Stop on Fail .....	33
2.4.1.9. Date and Time on Reports .....	34
2.4.1.10. Disable test failures due to ALC error .....	34
2.4.1.11. AQL (Acceptable Quality Level) .....	35
2.4.1.12. 14.5.1.12 Run audit test every [X] parts tested. ....	35
2.4.1.13. Fixture ID .....	36
2.4.1.14. External AC Source .....	36
2.4.1.15. Custom Text .....	36
2.4.2. Program Edit .....	37
2.4.3. Adding Tests .....	39
2.4.4. Inserting Tests .....	41
2.4.5. Modifying Tests .....	42
2.4.6. Deleting Tests .....	43
2.4.7. Reordering and Duplicating Tests .....	44

2.4.8.	Test Parameters .....	45
2.4.9.	Test Limits .....	46
2.4.10.	Using the Measure Button .....	48
2.4.11.	Run Your Program .....	51
2.4.12.	Compensation .....	55
2.4.13.	Hints and Tips .....	57
2.4.13.1.	Schematic .....	57
2.4.13.2.	Test Order .....	57
2.4.13.3.	Test Grouping .....	60
2.4.14.	Program Options Batch View .....	62
2.4.15.	Get Diagnostic Info .....	66
2.5.	Programming Specific Tests .....	67
2.5.1.	Load Compensation .....	67
2.5.2.	User Offset .....	69
2.5.3.	CTY - Continuity .....	70
2.5.4.	R - Winding Resistance .....	71
2.5.5.	RLS or RLP - Equivalent Series or Parallel Resistance .....	73
2.5.6.	LS or LP - Winding Inductance (Series or Parallel Circuit) .....	75
2.5.7.	LSB or LPB - Inductance with Bias (Series or Parallel Circuit) .....	77
2.5.8.	QL - Quality Factor .....	79
2.5.9.	D - Dissipation Factor or $\tan\delta$ .....	81
2.5.10.	LL - Leakage Inductance .....	83
2.5.11.	C - Interwinding Capacitance .....	86
2.5.12.	TR - Turns Ratio .....	88
2.5.13.	TRL - Turns Ratio (by Inductance) .....	93
2.5.14.	Z - Impedance .....	96
2.5.15.	ZB - Impedance with Bias .....	98
2.5.16.	R2 - Resistance Match .....	100
2.5.17.	L2 - Inductance Match .....	102
2.5.18.	C2 - Capacitance Match .....	104
2.5.19.	GBAL - General Longitudinal Balance .....	106
2.5.20.	LBAL - Longitudinal Balance .....	108
2.5.21.	ILOS - Insertion Loss .....	110
2.5.22.	RESP - Frequency Response .....	112
2.5.23.	RLOS - Return Loss .....	114
2.5.24.	ANGL - Impedance Phase Angle .....	116
2.5.25.	PHAS - Interwinding Phase Test .....	118
2.5.26.	OUT - Output to User Port .....	120
2.5.27.	HPDC - DC Hi-Pot (EHT) .....	121
2.5.28.	HPAC - AC Hi-Pot (EHT) .....	123
2.5.29.	LVOC - Low Voltage Open Circuit .....	125
2.5.30.	ACRT - AC Hi-Pot Ramp .....	127
2.5.31.	DCRT - DC Hi-Pot Ramp .....	128
2.5.32.	ACVB - AC Voltage Break Down .....	129
2.5.33.	DCVB - DC Voltage Break Down .....	130
2.5.34.	IR - Insulation Resistance .....	131
2.5.35.	SURG - Surge Stress Test .....	133
2.5.36.	ILK - Leakage Current Test .....	135
2.5.37.	MAGI - Magnetizing Current .....	137
2.5.38.	VOC - Open Circuit Voltage .....	139
2.5.39.	WATT - Wattage .....	141
2.5.40.	STRW - Stress Wattage .....	143
2.5.41.	LSBX - Inductance with DC1000 Bias (Series Circuit) .....	145
2.5.42.	LPBX - Inductance with DC1000 Bias (Parallel Circuit) .....	147
2.5.43.	ZBX - Impedance with DC1000 Bias .....	149
2.5.44.	MAGX - Magnetizing Current (AC Interface) .....	151
2.5.45.	VOCX - O/C Voltage ((C Interface) .....	153
2.5.46.	WATX - Wattage (AC Interface) .....	155
2.5.47.	STRX - Stress Watts (AC Interface) .....	157
2.5.48.	WAIT - Wait or Pause .....	159

2.5.49.	PWRF – Power Factor .....	160
2.6.	Firmware Upgrades .....	161
2.7.	Self-Test .....	163
2.8.	Customize Tester.....	165
<b>3.</b>	<b>Change Log.....</b>	<b>167</b>
3.1.	AT Editor dotNET software.....	167
3.2.	AT Editor dotNET manual.....	168



# 1. Introduction

## 1.1. AT Editor dotNET - New Features

The AT Editor dotNET is a complete rewrite of the AT Editor program.

This has allowed us to take advantage of native MS libraries for communications, to speed up results saving and to better support the USB functionality on the AT5600, as well as implement new and exciting features and tests quickly as the AT5600 and AT Editor develop in the coming months.

This new version still supports the AT3600 and ATi as well as the AT5600.

Programs that you have already created on the old Editors can be opened, edited, saved, and run using the new dotNET Editor (and corresponding dotNET Server) as the basic format of the ATP program files has not changed.

## What's New?

### 1.1.1. Auto Programming

#### New in V 4.2.8901, May 2024

The latest version of the dotNET Editor introduces our new optional Auto Programming feature.

#### What Is Auto-Programming ?

Auto Programming allows new (or existing) users to quickly create and run a test program.

While it is aimed at new customers who are not yet familiar with the AT Editor or AT5600, it is also beneficial to any existing customers, as it will rapidly create a test program with most of the tests you will need, which you can then refine further.

For example, it will automatically create a DCR test for every winding on your schematic, which can be time consuming for more advanced schematics.

#### How Does Auto-programming work?

1, First Select the Transformer type you wish to program using the drop-down menu.

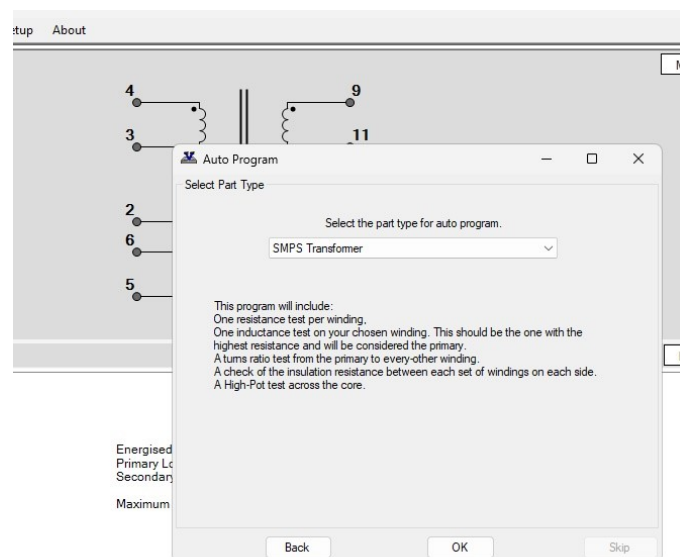

A brief description of the tests to be programmed will be shown.



- 2, Next follow the prompts to draw the schematic of your transformer.
- 3, Depending on the type you have selected the prompts will ask you to define the primary winding, and optionally to enter the voltage and frequency to energise.
- 4, The software will perform a series of automatic measurements, populate a relevant series of tests, and then allow you to save and run the program created.
- 5, You can then edit or amend the program, to narrow or widen Pass/ Fail limits , or add additional tests you may want to deploy.

### **How do I Use Auto Programming ?**

From the top menu, select Program > Auto Programming to start the process.

A Guide window will then open and step you through the process.

This window is floating so will remain open during the whole process to guide you.

### 1.1.2. Program Options - Batch View

Scan your chosen folder, to quickly view and review the program options you have set, without the need to open each program individually.

This report can then be kept open (or moved to another monitor), allowing you to open and update the programs you want to give you quicker management of your test program library.

File Name	Part Name	Fixture	Printing	Kelvin	Operator	Batch	Serial	Stop on Fail	Disable
DIAGNOSTIC-HP.atp	DIAGNOSTIC-HP	91-186							
DIAGNOSTIC.atp	DIAGNOSTIC	91-186							
91-295 SN 15.atp	91-295 SN 15	91-295 SN15			ALL	YES	YES		
01 CT16-15954 L.atp	01 CT16-15954 L	CT16-15954			ALL				
m.atp	RRR	CT16-15954			ALL				
07 MURTA 786 L.atp	07 MURTA 786 L	FIXTURE 289			ALL				
09 POE 7491199212 L.atp	09 POE 7491199212 L	FIXTURE 289			ALL				
02 B82731M2351A030 L.atp	02 B82731M2351A030 L	FIXTURE 290			ALL				
04 750811290 L.atp	04 750811290 L	FIXTURE 290			ALL				
10 CT100-5 L.atp	10 CT100-5 L	FIXTURE 290			ALL		YES		
11 ccfl 210607 L.atp	11 CCFL 210607 L	FIXTURE 290			ALL				
ATI B8273 L.atp	ATI B8273 L	FIXTURE 290			ALL	YES			
mmr.atp	RRRRR	FIXTURE 290			ALL				
SOF.atp	SOF	GFHDG						YES	
RSHORT.atp	RSHORT	R SWEEP ID109				YES	YES		
300mohm.atp	300MOHM	RSWEEP 109							
05 TALEMA 62072 L.atp	05 TALEMA 62072 L	TALEMA 62072			ALL		YES		
06 TCT40-01E07AB L.atp	06 TCT40-01E07AB L	TRIAD TCT40-01E07ABM			ALL				

See 2.4.14 for more details.

### 1.1.3. Test List Editing

Right click the test list now allows you to

- 1 - Quickly move existing tests up or down.
- 2 - Duplicate existing tests to make programming sweeps much faster.



See 2.4.7 for more details.

### 1.1.4. Resizable Windows

Schematic / Test list windows can be resized for better clarity of the test list when programming.

See 2.4.2 for more details.

### 1.1.5. Individual Test Run Time (AT5600 only)

If a program is run from the Editor, the results now also include the run time for each individual test, allowing you to make better informed decisions on test time efficiency.

 Run Program

ID	Test Type	Result	Unit	Pass/Fail	SubType	DSP Status	Polarity	Sign	PolPassFail	Time
1	R	442.78900	mOhm	PASS		0000				0.21
2	R	452.29100	mOhm	PASS		0000				0.15
3	LS	4.18405	mH	PASS		0000				0.12
4	TR	1.00491		PASS		0000	POL	+	PASS	0.31
5	C	80.18080	pF	PASS		0000				0.10
6	LL	821.95600	nH	PASS		0000				0.49
7	HPAC	22.20240	uA	PASS		0000				1.14
	OVERALL		PASS						2.53	

See 2.4.11 for more details.

### 1.1.6. Save Program and Result As PDF

As well as the legacy method of saving the results to CSV, or the program as a PDF, the dot NET Editor now also allows you to save the last test results AND program as one combined PDF, to allow better sharing of test protocol and result data with your customers or with Voltech if support is required.

<u>General Tests</u>	
<b>1.</b>	<b>Winding Resistance</b>
	Integration: Long
	High Terminal: 1
	Maximum Value: 600.00 mOhm
	Low Terminal: 3
Result	442.78900 mOhm
P/F	PASS
Stat	0000
-----	
<b>2.</b>	<b>Winding Resistance</b>
	Integration: Long
	High Terminal: 6
	Maximum Value: 600.00 mOhm
	Low Terminal: 4
Result	452.29100 mOhm
P/F	PASS
Stat	0000
-----	



See 2.4.11 for more details.

### 1.1.7. History of AT Editor Versions

	<b>AT Editor (Legacy Version)</b>	<b>AT Editor</b>	<b>dotNET AT Editor</b>
<b>Version</b>	V 3.30	V 3.56	V 4.00.00  (And ongoing development)
<b>PC O/S</b>	WINDOWS XP, 2000, VISTA, 7,8,10,11.  32-bit and 64-bit	WINDOWS 7,8,10,11  32-bit and 64-bit	WINDOWS 7,8,10,11  32-bit and 64-bit
<b>AT Testers Supported</b>	AT3600  ATi	AT5600  AT3600  ATi	AT5600  AT3600  ATi
<b>Program Options Batch View</b>	NO	NO	YES
<b>Duplicate and reorder tests</b>	NO	NO	YES
<b>Resizable windows</b>	NO	NO	YES

## 2. AT Series Editor Software

### 2.1. Installing the Editor Software

All software is available from the Voltech website [www.voltech.com](http://www.voltech.com).

#### 2.1.1. Computer Requirements

Before attempting to install any Windows software, check that the PC satisfies the following hardware requirements:

Operating system: Windows 7, 8,10,11.  
32 or 64 Bit.

#### 2.1.2. Installing the USB Drivers (AT5600 only)

If USB operation is required (as recommended) then download AT5600 USB drivers from the Voltech website and follow the instructions for installing the drivers. After installation, when the AT5600 is connected via the USB port, a virtual COM port will be created through which you can communicate with the AT5600.

To determine which COM port has been assigned, ensure the AT5600 is powered on.

1. Navigate to the Device Manager on your PC.
2. Left click on the Ports (COM & LPT)
3. Shown in the example below, you will see that COM27 has been assigned to the AT5600.

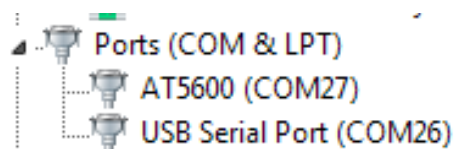

### 2.1.3. Installing the main application

Download and follow the instructions to install the AT Editor software.

The installation program will suggest a folder in which to place the Editor files:

c:\Program Files\Voltech Instruments\Voltech AT Editor

This directory will be created if it does not already exist.

If you want to place the files elsewhere, browse to another directory.

If you have a previous version of the Editor software already installed on your PC, the procedure outlined above may also be used to install a new version.

The same Editor program is used for all AT Series testers (excluding the discontinued AT3500 and AT1000).



## **2.2. Starting for the first time**

### **2.2.1. Running the software**

When the installation of the Editor has been completed, you will see the Editor icon in the program group 'Voltech Software'.

Click with the left mouse button on the Editor icon to start the program.

### **2.2.2. Communications Configuration**

Configure the Editor to use the COM Port installed for the AT tester.

This can be either.

- A) a local RS232 port,
- B) a RS232 port provided by a USB-RS232 converter,
- C) for the AT5600 a direct USB connection provided by the AT5600 USB drivers

From the Top Level 'Setup' menu, select 'Communications'.

In the dialogue box shown here, select the PC communications port which is connected to the tester and then click OK.

## 2.3. Creating the Schematic

The first step in creating a test program is to draw a schematic diagram.

This tells the Editor software which test nodes will be used to make electrical connections to the part under test and allows error checking to be performed when programming the tests.

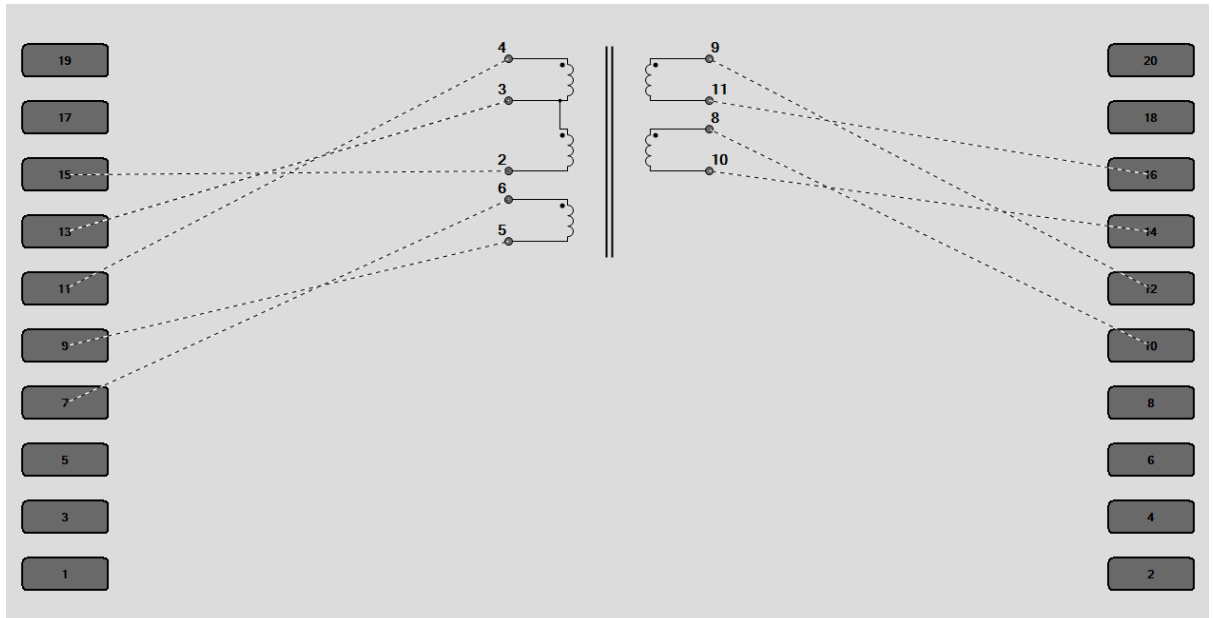

A schematic is also a great visual reference while creating the test program.

This section covers how to:

- Create or add a transformer winding.
- Connect the winding terminals to test nodes.
- Delete a winding.
- Rename a terminal.
- Add a terminal.
- Delete a terminal.
- Add a core connection.
- Delete a core connection.
- Add a screen connection.
- Delete a screen connection.

### 2.3.1. Adding a Transformer Winding

To add a transformer winding onto the screen:

Select 'Add Left Winding' or "Right Winding" from the Schematic menu on the menu bar, depending on which side of the screen you wish to add the winding.

This is an arbitrary choice, but the usual convention is to keep primaries on the left and secondaries on the right hand side

Enter the terminal names you wish to use. Terminal names may be between 1 and 6 characters in length and may contain any upper-case letter or AT Series keyboard character excluding SPACE.

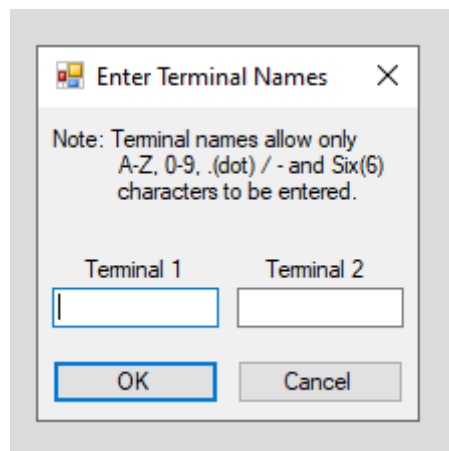

When both terminals have been named, you should press ENTER on the keyboard or click on OK with the mouse in the dialogue box.

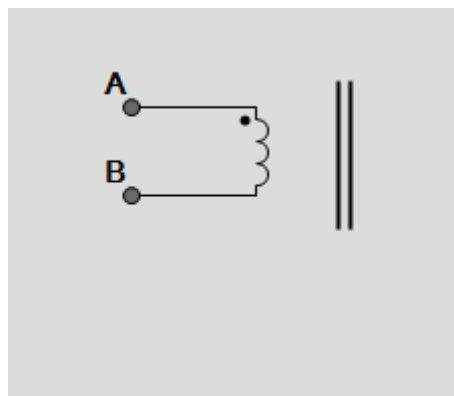

To make a winding with more than two terminals (for center taps or auto transformers), see "Adding a Terminal to an Existing Winding".

### 2.3.2. Connecting the Winding Terminals to Nodes

To connect the winding terminals to AT test nodes:

Select a terminal to connect with the RIGHT mouse button.

Keeping the right button pressed, drag the wire to the selected test node.

When the mouse pointer is over the test node, release the mouse button.

The connection may also be made in reverse by first selecting the test node and then connecting it to the winding terminal.

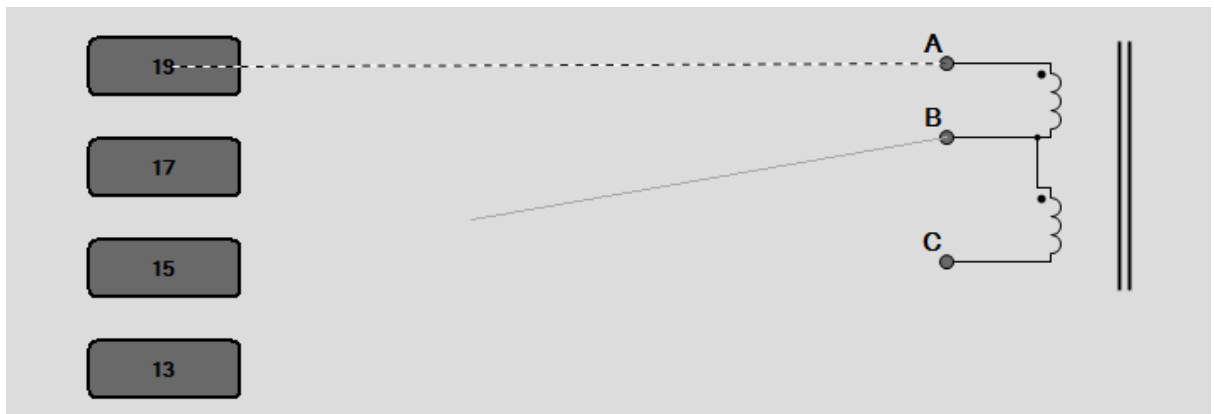

To change a connection, simply use the right button to pick it up and move it to either another test node or to another transformer terminal.

To delete a connection, again use the right mouse button to pick up the connection, but this time release it when it is not over either a node or a terminal.

### 2.3.3. Deleting a Winding

Select a winding by pointing at it with the mouse pointer and clicking the left mouse button once. A selected winding will be indicated by a box surrounding the winding.

Choose 'Delete Winding' from the 'Schematic' menu.

The selection will be removed from the screen.

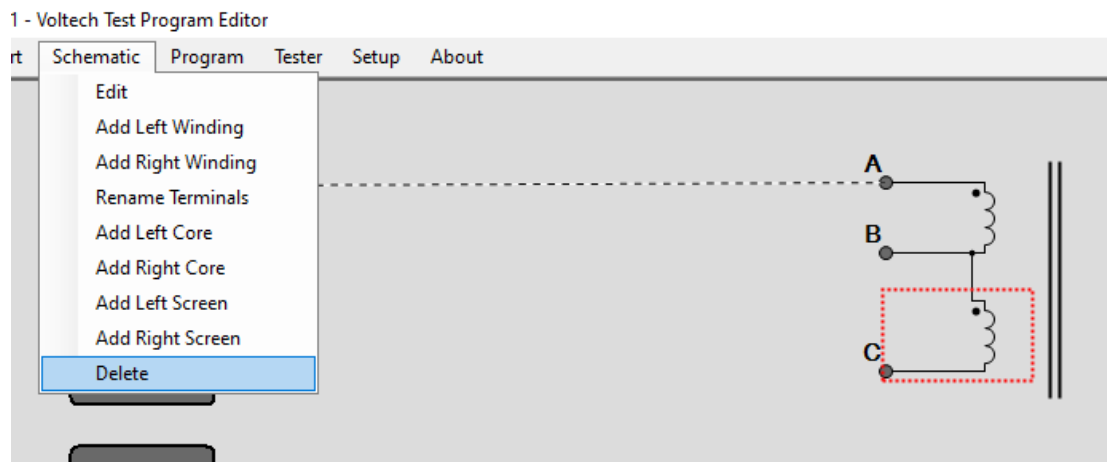

### 2.3.4. Renaming a Terminal

Select the winding containing the terminal to rename by using the mouse pointer and clicking the left mouse button.

Choose 'Rename Terminals' from the 'Schematic' menu.

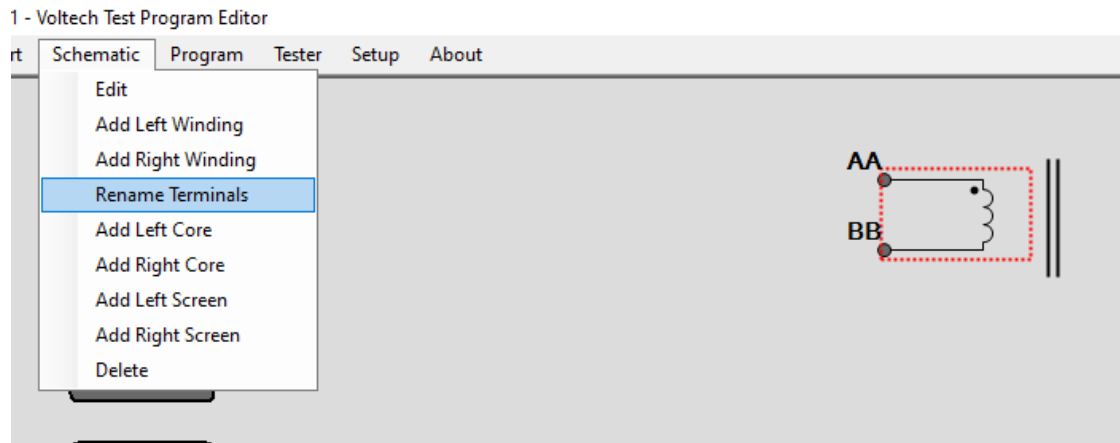

A dialogue box will appear.

By clicking the Yes Button, you can continue to allow rename the terminal.

Each fill-in box will contain the current names of the winding terminals, allowing you to change them if you wish.

If you click the No button, renaming will be aborted.

### 2.3.5. Adding a Terminal to an Existing Winding

To add a terminal to a transformer winding (e.g. for center taps or auto transformers)

1. Select 'Add Winding' from the 'Schematic' menu on the menu bar to create a second two terminal winding.
2. Now place the new winding on the same side of the schematic as the winding which requires the additional terminal.

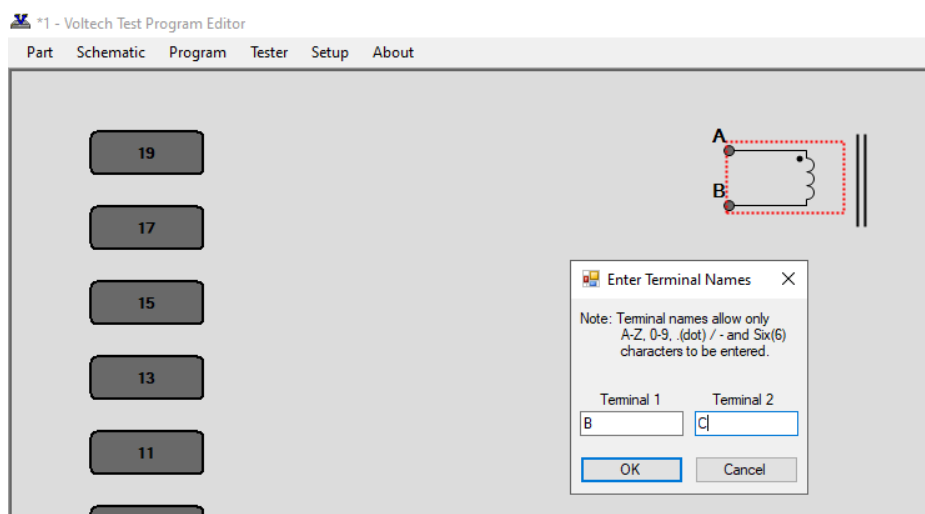

Upon clicking the left mouse button, a form fill-in dialogue box will appear on the screen with prompts to insert the terminal names of the new winding.

3. Name the terminals of the second winding, giving one terminal the same name as a terminal of the previous winding.
4. Press ENTER or click on OK.

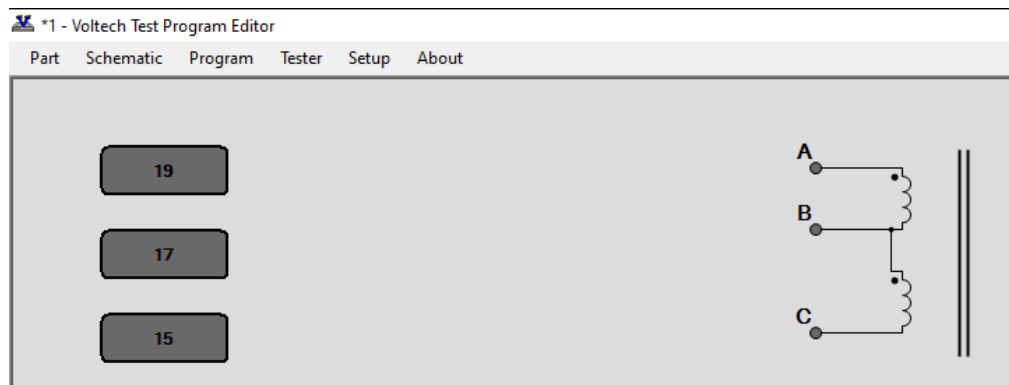

The dialogue box will be removed, and the schematic will show the two windings joined at the common terminal.

### 2.3.6. Deleting a Terminal from an Existing Winding

To remove a terminal from a transformer winding:

Select the terminal which you would like to be removed by using the mouse pointer and clicking the left mouse button once.

Choose 'Delete' from the 'Schematic' menu on the menu bar.

A confirmation prompt will appear. On Clicking YES, then the bottom terminal of the winding will be removed from the screen, together with any connections to that terminal which are present.

### 2.3.7. Adding a Core Connection

To add a core connection:

Choose 'Add Core Connection' from the 'Schematic' menu.

A connection from the core will appear on the screen.

You may now add a core-to-node connection.

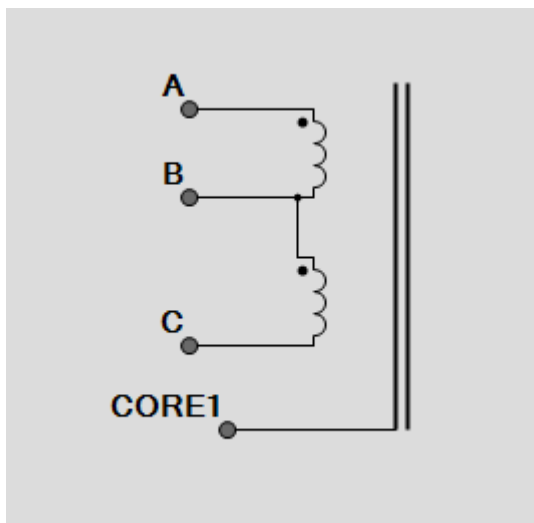

### 2.3.8. Deleting a Core Connection

To delete a core connection:

Select the core which you would like to be removed by using the mouse pointer and clicking the left mouse button once.

Choose 'Delete' from the 'Schematic' menu.

A confirmation prompt will appear. On Clicking YES, then the selection will be removed from the screen, together with any connections to that terminal.



### 2.3.9. Adding a Screen Connection

To add a screen connection:

Choose 'Add Screen Connection' from the 'Schematic' menu.

A connection from the screen will appear on the schematic.

You may now add a screen-to-node connection.

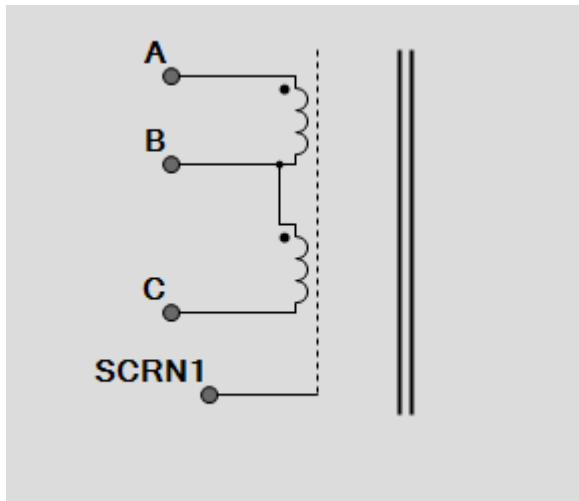

### 2.3.10. Deleting a Screen Connection

To delete a screen connection:

Select the connection you wish to delete by pointing at it with the mouse prompt and pressing the left mouse button.

Choose 'Delete Screen Connection' from the 'Schematic' menu.

A confirmation prompt will appear. On Clicking YES, then the selection will be removed from the screen, together with any connections to that terminal.

The screen connection will be removed from the schematic.

## 2.4. Creating the Program

This describes how to populate the program with the tests you wish to employ.

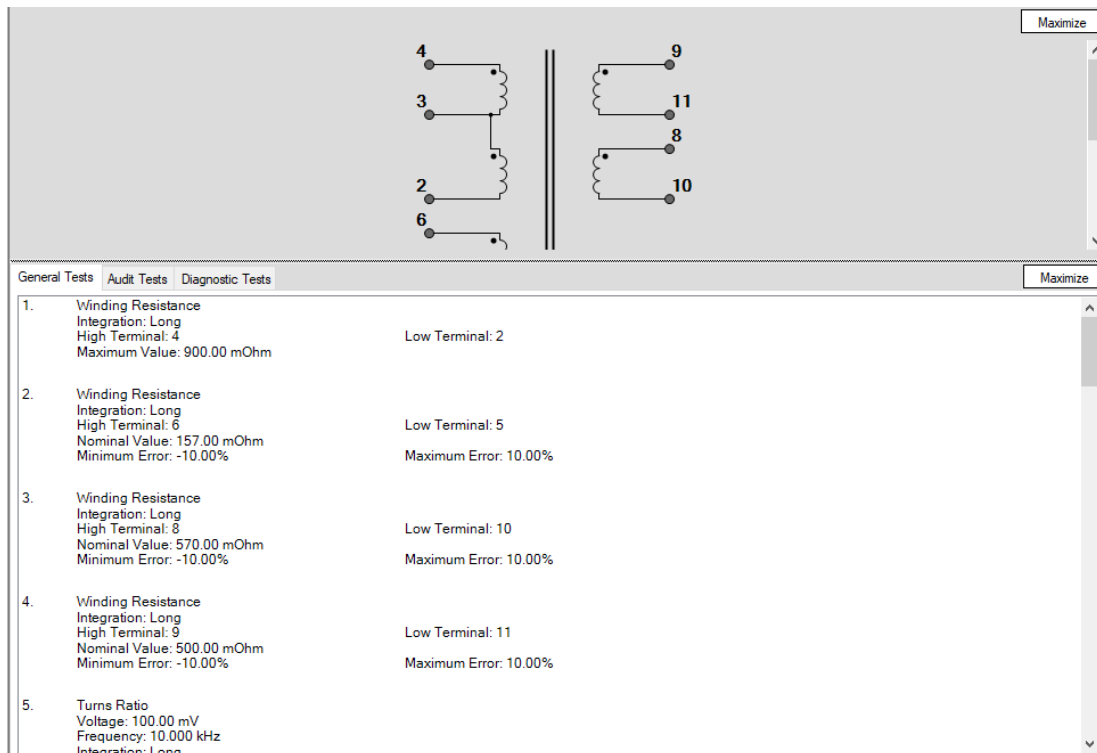

The screenshot displays the AT Editor software interface. At the top, there is a circuit diagram with two coils connected to terminals 2, 3, 4, 6, 8, 9, 10, and 11. Below the diagram is a list of tests under the 'Diagnostic Tests' tab. The tests are as follows:

Test ID	Test Name	Integration	High Terminal	Low Terminal	Other Parameters
1.	Winding Resistance	Long	4	2	Maximum Value: 900.00 mOhm
2.	Winding Resistance	Long	6	5	Nominal Value: 157.00 mOhm Minimum Error: -10.00% Maximum Error: 10.00%
3.	Winding Resistance	Long	8	10	Nominal Value: 570.00 mOhm Minimum Error: -10.00% Maximum Error: 10.00%
4.	Winding Resistance	Long	9	11	Nominal Value: 500.00 mOhm Minimum Error: -10.00% Maximum Error: 10.00%
5.	Turns Ratio	Long			Voltage: 100.00 mV Frequency: 10.000 kHz

By the end of this section, you will be able to:

- Set up the program options.
- Add a test to the program.
- Insert a test in the program.
- Modify an existing test in the program.
- Delete a test.
- Use the measure button to create test parameters.
- Verify the program - including compensation of the fixture.

## 2.4.1. Setting the Program Options

After you have created the program schematic, before starting to insert any tests in the program, you should set up which program options you would like to use.

From the Top-Level menu bar, select **Program > Option**.

You will then see the following dialogue box:

Configuration

Results Printing

Off  Failures Only  Full Reporting

Kelvin Pre-Check

Off  Ignore O/C Comp  All

Header Options

Operator Numbering  Send Results To Server

Batch Numbering  Send Retry Results To Server

Serial Numbering  Aql No. Of Parts

Stop On Fail  Aql % Of Parts

Date And Time On Reports

Disable Test Failures due to ALC Error

Others

Run audit tests every:

Fixture Name:

External AC Source:

Custom Text

Display Text On AT

OK Cancel

You may now set up any of the following options by simply clicking with the left button of the mouse:

### **2.4.1.1. Results Printing**

Printed reports may be obtained from the USB 'A' port of the tester as follows:

**Off** - There will be no results printed out during the test execution.

**Failures Only** - The results of the tests producing a "failure" result will be printed.

**Full Reporting** - The results for all the tests in the program will be printed out for each transformer tested.

### 2.4.1.2. Kelvin Pre-Check

#### (New feature in AT5600 FW 0.007.220)

The goal of the Kelvin check is to verify that there is continuity between the power and sense lines for all nodes that are used in the test program. Over the course of running a large batch of parts, the Kelvin connections could potentially become contaminated with debris, varnish or could be simply misaligned to a specific part.

This pre-test of the connections provides a useful validation that the component is fitted properly, which provides the best confidence in the following testing, as it provides a check that the UUT is connected before any testing commences.

It also provides the same check before compensation to make sure the compensation applied (for all later tests in a batch) is not bad, due to accidental bad connections during compensation.

The check is run before the normal test sequence, and so sits “before” the normal test program sequence. Hence any bad results due to connections are not sent to the server, resulting in misleading false fail records. The user then has the chance to correct any bad connections and resume the test.

The Kelvin Pre-check does not tell you anything about the actual transformer under test but does confirm that SOURCE and MEASURE nodes are connected to every pin used in the test. Hence it is still valid to use CTY and R to check your actual UUT windings.

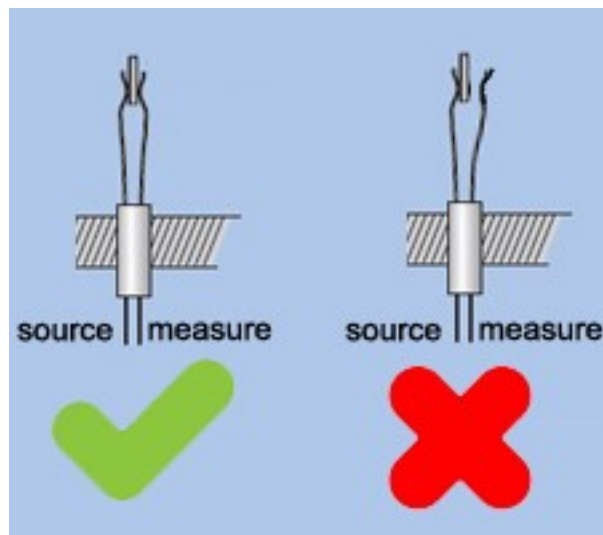

### What is Tested?

Any node (1-20) connected to a winding, core or screen terminal on the schematic is tested once, even if the terminal is not used in a test.

### How a Kelvin Check is Performed

To perform the Kelvin check, each node has the sense line shorted to ground and the power line is energized with a low voltage. If the connection between the power and sense lines is poor, the easiest path for the current to take is through the current sensing shunt and a large current will be measured. If the connection is strong, the current sensing shunt will be bypassed, and the measured current will be small.

Any resistance lower than 5 Ohms from power to sense will pass the test, and any resistance higher than 5 Ohms will fail the Kelvin check.

If there are one or more failures, a failure report will be shown which indicates which node number failed and a terminal name that corresponds to that node. This screen provides three options. The user can adjust their connections to resolve the issue and RETRY, ignore the failure, and CONTINUE with testing, or ignore the failure and CANCEL the testing. In the case of retry and ignore, the execution is resumed by pressing the RUN button.

Program Execution

<p>This table indicates the nodes and terminals that have failed the Kelvin test. Please check your connections.</p> <p>Select RETRY (default) and press RUN to retest the connections.</p> <p>Select CONTINUE and press RUN to ignore this failure.</p> <p>Press CANCEL to abort and return to the previous screen.</p>	<table border="1" style="border-collapse: collapse; width: 100%;"> <thead> <tr> <th>#</th> <th>Terminal Name</th> </tr> </thead> <tbody> <tr><td>1</td><td>ATENLO</td></tr> <tr><td>3</td><td>ATTENM</td></tr> <tr><td>5</td><td>ATTENHI</td></tr> <tr><td>7</td><td>VIOLET</td></tr> <tr><td>8</td><td>BLUE</td></tr> <tr><td>9</td><td>RED</td></tr> <tr><td>10</td><td>BROWN</td></tr> <tr><td>11</td><td>BLACK</td></tr> <tr><td>12</td><td>RED2</td></tr> <tr><td>13</td><td>YELLOW</td></tr> <tr><td>14</td><td>GREEN</td></tr> <tr><td>15</td><td>COMUN</td></tr> <tr><td>17</td><td>208</td></tr> <tr><td>18</td><td>SEC2</td></tr> <tr><td>19</td><td>230</td></tr> <tr><td>20</td><td>SEC1</td></tr> </tbody> </table>	#	Terminal Name	1	ATENLO	3	ATTENM	5	ATTENHI	7	VIOLET	8	BLUE	9	RED	10	BROWN	11	BLACK	12	RED2	13	YELLOW	14	GREEN	15	COMUN	17	208	18	SEC2	19	230	20	SEC1	<div style="background-color: #4a7ebb; color: white; text-align: center; padding: 10px; margin-bottom: 10px; font-weight: bold;">RETRY</div> <div style="background-color: #c0c0ff; text-align: center; padding: 10px; margin-bottom: 10px; font-weight: bold;">CONTINUE</div> <div style="background-color: #c0c0ff; text-align: center; padding: 10px; font-weight: bold;">CANCEL</div>
#	Terminal Name																																			
1	ATENLO																																			
3	ATTENM																																			
5	ATTENHI																																			
7	VIOLET																																			
8	BLUE																																			
9	RED																																			
10	BROWN																																			
11	BLACK																																			
12	RED2																																			
13	YELLOW																																			
14	GREEN																																			
15	COMUN																																			
17	208																																			
18	SEC2																																			
19	230																																			
20	SEC1																																			

☰
10:24

## Editor Settings

The editor has three settings for performing the Kelvin check. They are as follows:

Off - This is the default state and what is used for older programs where the Kelvin check state is not specified. In this mode, no Kelvin checks are performed.

Ignore O/ Comp - This is a relaxed testing mode which requires the Kelvin check to pass during short circuit compensation, load compensation and test execution. Open circuit compensation will not have a Kelvin check. This mode is recommended if there is only low frequency testing, as you can simply remove the fixture to do open circuit compensation.

All - This mode is a strict testing that will execute the Kelvin check before any compensation or test execution. This mode is recommended to get the best connection reliability.

## Legacy Products (AT3600, ATi)

This test option is not available on the AT3600 or ATi.

However, programs with the Kelvin option enabled can still be used on these products, but the flag will simply be ignored.

This prevents users from maintaining two separate test programs and maintains ATP program portability between unit types.

### **2.4.1.3. Operator Numbering**

During program execution, the operator will be prompted to enter his or her identity code. All server results will then be tagged with this code.

### **2.4.1.4. Batch Numbering**

During program execution, the operator will be prompted to enter a batch number, which will be attached to the server test results.

### **2.4.1.5. Serial Numbering**

During program execution, the operator will be prompted to enter a serial number for each transformer (or you can select auto-increment). The number will then be attached to the server results for the next transformer test.

### **2.4.1.6. Send Results to Server**

Select this option if you wish to have the tester send all the measurement results back to the Server PC for archive or analysis.

### **2.4.1.7. Send Retry Results to Server**

Enable this function if you wish the Server archive to contain the results from the additional measurements associated with re-running a program, for example after execution has been halted by the STOP ON FAIL program option.



### 2.4.1.8. Stop on Fail

With this function enabled, the tester will stop program execution whenever a failure is detected, rather than carrying out all the tests in the test program and reporting the passes and fails at the end. Please note this does NOT apply if running the program from the EDITOR, only from the front panel when using the SERVER.

This enables the user to quickly identify a faulty transformer and replace it with another before all the tests have been carried out, thus speeding up the test process.

When a failure is encountered, the tester shall stop the program.

The display will inform the user of a test failure and indicate which test has failed, as shown below.

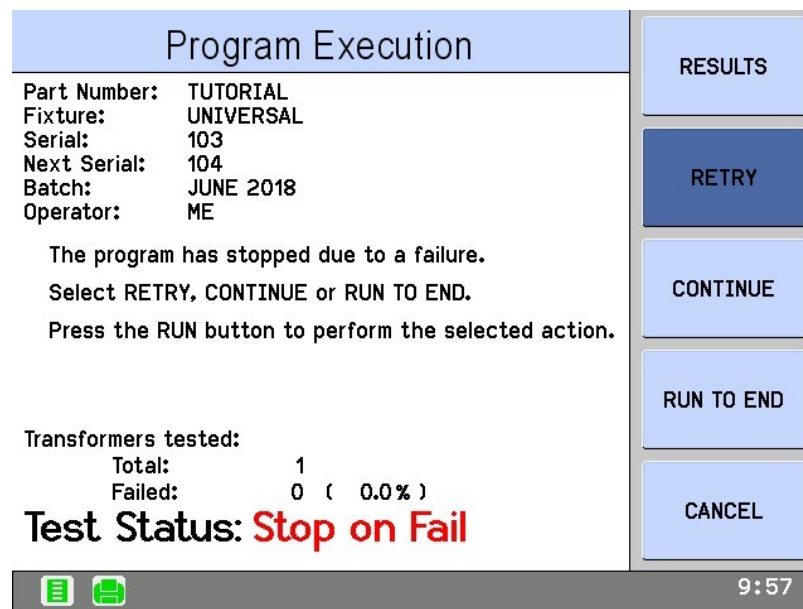

From this display, the operator has the choice to perform the following.

**RESULTS** view the test results recorded so far.

**RETRY** Discard the results and run from the beginning again. Useful if the cause of the failure is just misconnection that you have diagnosed and corrected. This also stops False Fails being recorded in your results.

**CONTINUE** The tester will execute the remaining tests in the program, and the transformer will be recorded as a failure. (If any further tests fail, then there will be another display like the one above for each failing test.)

**RUN TO END** Disable STOP ON FAIL for the rest of the run. Useful if you have a long program with many fails that you wish to let run.

**CANCEL** Terminate this program run, and return to the Execute display, from where you can start the program again for the next transformer in the batch.

### **2.4.1.9. Date and Time on Reports**

AT3600+ ATi only

Enable this option to have the date and time on the printer results printout.

AT5600

All printed results using the USB printer will have data and time on them regardless of this setting.

### **2.4.1.10. Disable test failures due to ALC error.**

Under test conditions where the load is mismatched to the requested test signal, then the voltage or current may not be met (to within nominal spec of 1%).

In these cases, the unit will return a STATUS ERROR of "0020" (see AT5600 user manual section 9.1.3).

This indicates that, while the measured parameter may be within your requested limits, the test itself is a FAIL, as the requested test conditions were not met. This is analogous to ALC (Auto Level Control) on the most popular LCR meters.

With this option enabled, the AT5600 will make the PASS/FAIL judgement purely based on the measured parameter and ignore the "0020" error code.

The AT3600 and ATi units always make the PASS/FAIL judgement on limits alone, so enabling this option will help users with compatibility to these platforms.

Please note: The AT3600 and ATi firmware do NOT support this option; Regardless of the option setting, the 0020 status will never be part of the PASS/FAIL criteria for these units.

### **2.4.1.11. AQL (Acceptable Quality Level)**

Settings for production test are defined here. AQL is the level of test failures in a batch that is acceptable. Exceeding the AQL is an indication that there is a problem with the quality of the production process or the quality of materials that are being used. AQL monitoring is an optional feature of the Voltech PC Server, which displays live summary results from multiple AT testers. When the AQL set here is reached or exceeded, the Server will display a warning. Both types of AQL limits may be used at the same time. Reaching any one limit will cause a warning to be displayed on the Server.

For further details, see the AT Server section of this manual.

**AQL No. of Parts** - This is the number of failures in the batch at which a warning will be displayed on the Server. This is most often used when the batch size is always similar, or zero / very small numbers of defects are expected.

**AQL % of Parts** - This is the percentage level of failures at which a warning will be displayed on the Server. Note that this AQL is only applied after sufficient parts have been tested to make the percentage meaningful. When setting AQL % of Parts to be 1%, for example, a warning will only be displayed after  $100/1 = 100$  parts have been tested.

### **2.4.1.12. 14.5.1.12 Run audit test every [X] parts tested.**

Defines the frequency that Audit Tests are to be performed.

**NOTE: AUDIT and DIAGNOSTIC results.**

Audit AND Diagnostic tests, on a “not run” cycle, will return a PASS and a numeric value of 0.0000.

This is so they can be easily identified as not having been executed and can be easily identified and removed from results for analysis.

### **2.4.1.13. Fixture ID**

Used to enter the test fixture name.

The Fixture Name can be up to 20 characters long. You may use any of the characters which appear on the tester's keyboard:

A ... Z (upper case only) and 0 1 2 3 4 5 6 7 8 9 - / ( ) and 'space'

When the test program is run on the AT Series Tester, the operator will be prompted to fit the fixture with this name. This will help to make sure that the correct fixture is used.

Note that the fixture name does not have to be the same as the program (part) name. This makes it possible to have one fixture common to several transformers which may, for example, have the same arrangement of pins, but have different windings requiring different test programs.

### **2.4.1.14. External AC Source**

It is possible to use an external AC source to generate the test signal for testing. Using an external source extends the power and voltage range available.

The source must be coupled to the tester via a Voltech AC Interface Fixture (contact your supplier for details). This option allows you to choose and configure the type of external source you will be using; see the External AC Source Interface user manual for details.

If you are not using an external source, it is IMPORTANT that the source type is set to 'None'.

### **2.4.1.15. Custom Text**

Implemented on V1.001.000 Firmware.

7 lines of 28-character text can be stored here for general program notes.

Enabling the "Display text on AT" tick box will also display the text on screen on initial program load. For example, for any part specific instructions you wish the operator to see.

When you have selected all the required options, click on the OK button to return to the top-level menu.

## 2.4.2. Program Edit

After you have created the program schematic, and selected the program options, you may then start creating the actual program of tests.

To edit the test program, you must first switch to the Program Editor.

From the Top-Level menu bar, select **Program > Edit.**, or MINIMISE the schematic.

You will now see a display with three separate windows:

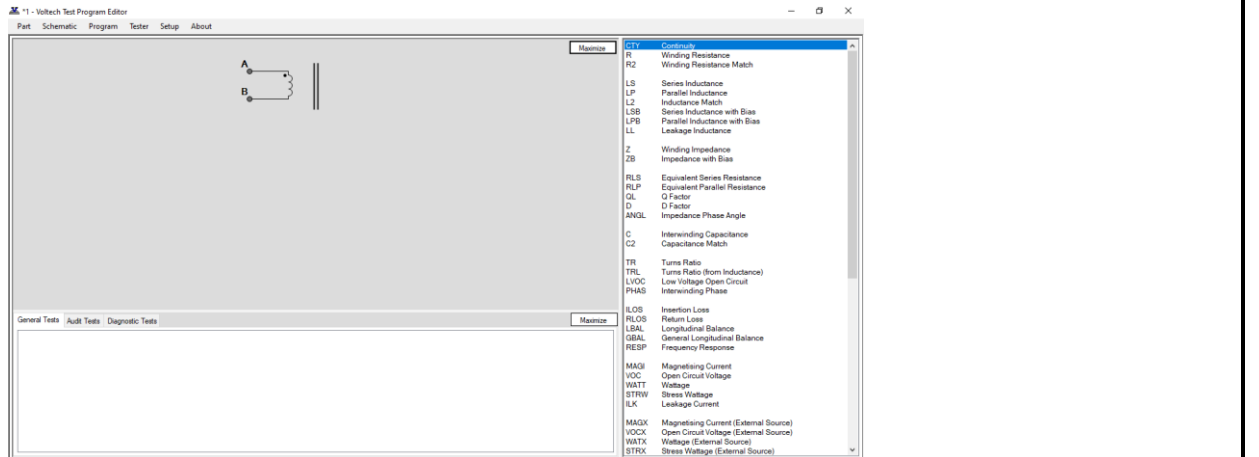

The 3 windows can be resized by hovering over the border and clicking and dragging them.

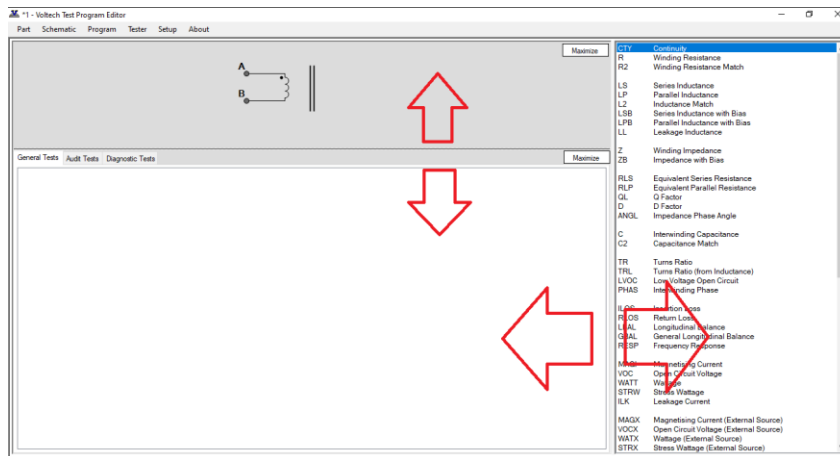

### The three windows show –

**Top Left:** A simplified view of the transformer schematic omitting the wiring to the nodes. This is a passive window intended to be used as a memory aid; it cannot be used to change the schematic. (If you need to alter the schematic at any time, simply click on 'Schematic' then 'Edit' in the Top-Level menu.)

**Bottom Left** the Program Window contains three tabs.

Normally, for a new program, this window would initially be empty.

- General Tests - list of tests which currently make up the normal test program.
- Audit Tests - additional tests to be periodically performed, the frequency is defined by program option.
- Diagnostic Tests - additional tests to be performed if a failure occurs.

**Right** the Available Tests Window.

This is the list of tests which are available to be used in creating or modifying the test program. Tests which are not available for use shall be greyed out.

Contact your Voltech sales office to purchase tests that are not available.

From this display, you may now create the test program suitable for your transformer by adding tests to the Program from the Available Tests list.

The following sections describe how to do this.

### 2.4.3. Adding Tests

A test program is a list of tests chosen from the Available Tests list.

To create a new program, you simply add tests to the list.

To add a test, select the tab of the type of test it shall be by clicking on the tab of the Program List window located in the bottom left of the screen.

General Tests - list of tests which currently make up the normal test program.

Audit Tests - additional tests to be performed every X test run, the frequency is defined by program option. X=2 to 99.

Diagnostic Tests - additional tests to be performed if a failure occurs.

**NOTE: AUDIT and DIAGNOSTIC results.**

Audit AND Diagnostic tests, on a “not run” cycle, will return a PASS and a numeric value of 0. 000. This is so they can be easily identified as not having been executed and can be easily identified and removed from results for analysis.

Use the mouse to select the test you require from the Available Tests list, and double click on that test with the left button.

This will open the dialogue box particular to that test.

You simply fill in all the fields of the dialogue box, and then click on the OK button.

The test will be added at the end of the Program. As an example, if you wish to add another 'R Winding Resistance' to the program, then Double click on the 'R Winding Resistance' test in Available Test list.

Fill in the fields of the dialogue box.

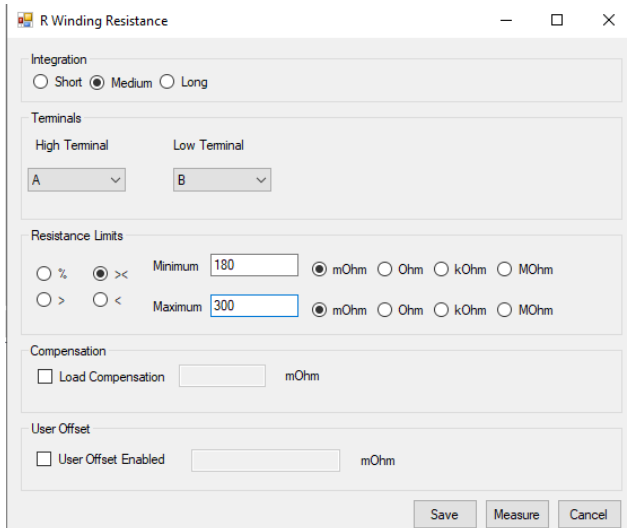

Click on the OK button.

You will now see this test added to the Program:

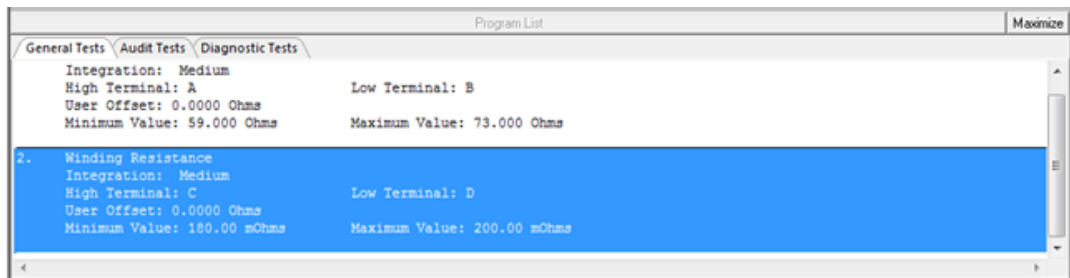



## 2.4.4. Inserting Tests

Normally, if you are creating a new test program, you would add the tests in the correct order of execution, as described in the previous section. You would also use this procedure for modifying an existing program if you needed to append further tests at the end.

However, if you wish to add an extra test somewhere in the middle of an existing program, a different procedure is required:

In the Available Tests window, click with the left button of the mouse to highlight the test you wish to insert.

In the Program window, click with the left mouse button to highlight one of the existing tests in the list. This will become the point of insertion; the new test will be inserted in front of the one you have selected.

From the Top Level menu bar, select **Program > Insert Test**.

You will now see the dialogue box for the test you wish to insert.

Enter the appropriate test data in the fields of the dialogue box, and click on OK.

You will now see the new test inserted into the Program.

### 2.4.5. Modifying Tests

As part of creating a new test program, you would normally experiment by running it with a sample batch of transformers.

At this point, you may find that some tests need to be modified, a typical example being that you need to change the test limits.

With the Editor software, modifying a test is very simple.

In the Program window, double-click with the left mouse button on the test you wish to modify. This will re-open the dialogue box for that particular test.

Make any changes you require to the test data in the fields of the dialogue box, and click on OK.

You will now see the test with the modified data in the Program window.

## 2.4.6. Deleting Tests

To delete a test from the Program, with the Editor software is very simple.

In the Program window, click with the left mouse button to highlight the test you wish to delete.

Then either

A press Delete on the keyboard.

Or

B, From the Top-Level menu bar, select Program > Delete Test

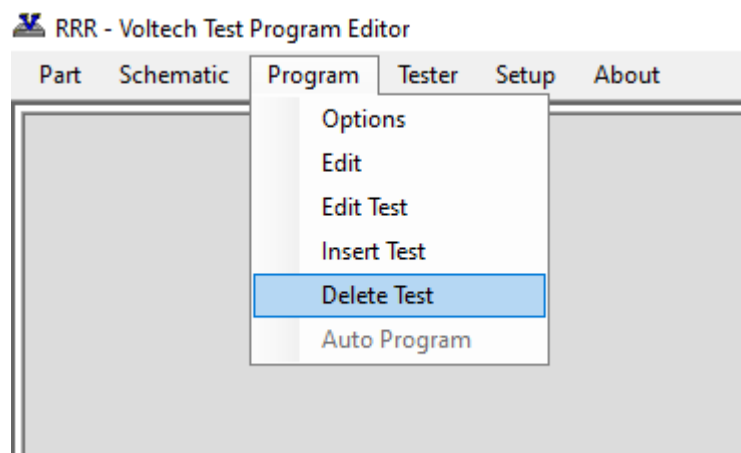

You will now see the test has been removed from the list in the Program window.

### 2.4.7. Reordering and Duplicating Tests

This is a new feature of the dotNET Editor not available in the legacy (V3.xx) version.

If you select a test in the existing program list and right click, you will be given 3 options.

**Move test up** – the selected test will be moved up the list – in the below example, test 2 will become test 1 (and #1 will become #2)

**Move test down** - the selected test will be moved down the list – in the below example, test 2 will become test 3. (And #3 will become #2)

**Duplicate Test** – the selected test will be duplicated, and a copy inserted after the current selection. This is helpful when programming a sweep of tests for example over a range of frequencies, where most of the test conditions are the same, but you wish to change only one or two parameters, such as frequency and Pass /Fail limits.

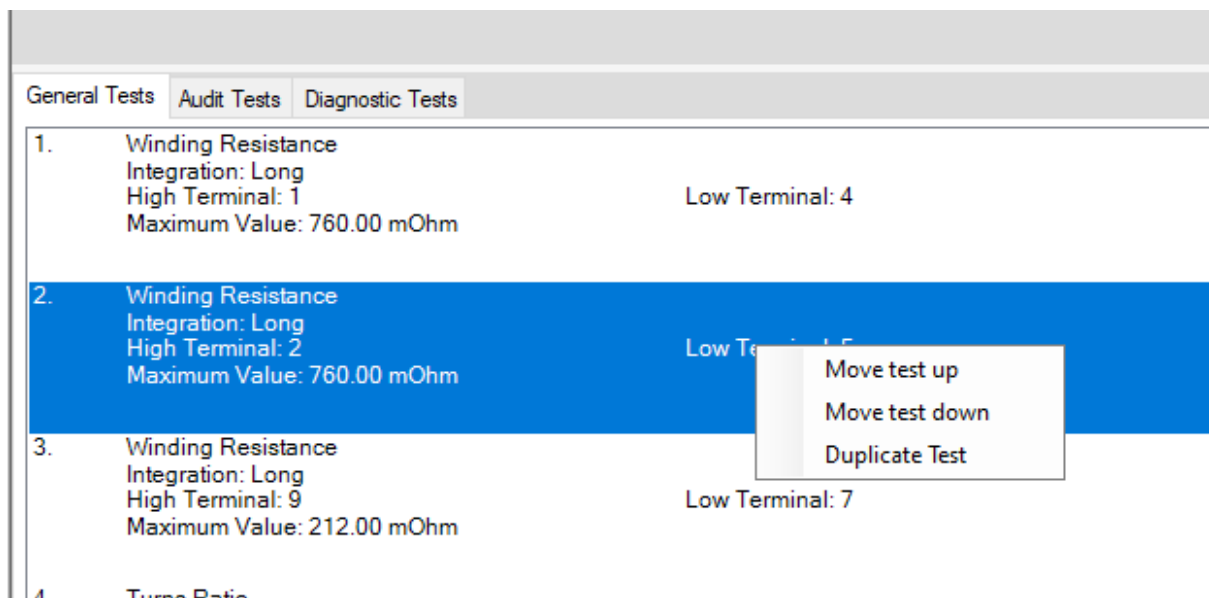

## 2.4.8. Test Parameters

Some tests such as the R-Winding Resistance test are relatively simple to program because you do not have to set up any test conditions. This is not the normal case.

The LS - Winding Inductance (Series Circuit) - test is more typical, requiring the test parameters 'Signal' and 'Frequency' to be specified.

The screenshot shows the 'LS Series Inductance' dialog box with the following settings:

- Integration:** Short  Medium  Long
- Test Parameters:** Signal: 100, Frequency: 10. Units: mV  V  mA  Hz  kHz  MHz
- Terminals:** High Terminal: 1, Low Terminal: 4
- Inductance Limits:** Minimum: 900, Maximum: 1.1. Units: nH  uH  mH  H  kHz
- Compensation:** Load Compensation  nH
- User Offset:** User Offset Enabled  nH

Buttons at the bottom: Save, Measure, Cancel.

At this point you would type in the test parameters if, for example, they have been specified by the designer of the transformer.

If you are not sure what values to use, some guidance is given in chapter 7 (Tests & Test Conditions) in the AT5600 user manual.

You may use the Measure button to measure the part under test and set your limits, accordingly, as described in later in this chapter.

To do this in the case of the LS test, enter the Signal and Frequency levels into the edit boxes and enter the terminals before you click on the Measure button. Note that some tests do not have a Measure button.

### 2.4.9. Test Limits

Most tests have several ways in which the limits may be entered, allowing you greater flexibility in configuring each test to match your production testing requirements.

The four types of limits for the R- Winding Resistance -test are:

**% The limits are entered as positive and negative percentages about a nominal value.**

The screenshot shows the 'R Winding Resistance' dialog box. Under the 'Resistance Limits' section, the '% ><' radio button is selected. The 'Nominal' value is set to 5. The 'Negative' limit is set to 10% and the 'Positive' limit is set to 10%. Other options like '><', '>', and '<' are unselected. The 'Integration' section has 'Long' selected. 'Terminals' are set to High Terminal 1 and Low Terminal 4. 'Compensation' and 'User Offset' are both disabled.

**> < The limits are entered as minimum and maximum values.**

The screenshot shows the 'R Winding Resistance' dialog box. Under the 'Resistance Limits' section, the '><' radio button is selected. The 'Minimum' value is set to 4 and the 'Maximum' value is set to 5. The '% ><', '>', and '<' radio buttons are unselected. The 'Integration' section has 'Long' selected. 'Terminals' are set to High Terminal 1 and Low Terminal 4. 'Compensation' and 'User Offset' are both disabled.

> **There is only a minimum limit.**

The screenshot shows the 'R Winding Resistance' dialog box with the following settings:

- Integration:** Short, Medium, Long (Long is selected)
- Terminals:** High Terminal: 1, Low Terminal: 4
- Resistance Limits:** Minimum: 4, mOhm, Ohm (selected), kOhm, MOhm
- Compensation:** Load Compensation (unchecked), mOhm
- User Offset:** User Offset Enabled (unchecked), mOhm

Buttons: Save, Measure, Cancel

< **There is only a maximum limit.**

The screenshot shows the 'R Winding Resistance' dialog box with the following settings:

- Integration:** Short, Medium, Long (Long is selected)
- Terminals:** High Terminal: 1, Low Terminal: 4
- Resistance Limits:** Maximum: 5, mOhm, Ohm (selected), kOhm, MOhm
- Compensation:** Load Compensation (unchecked), mOhm
- User Offset:** User Offset Enabled (unchecked), mOhm

Buttons: Save, Measure, Cancel

Many of the tests available for the AT Series have all four limit types. There are obviously some tests where it is not sensible to have four limits, IR - Insulation Resistance - being a clear example where only a minimum limit is applicable, as the perfect insulation between windings has no upper limit to its resistance.

To choose which type of limit you wish to use, simply use the mouse to click on one of the buttons %, > <, >, or <.

## 2.4.10. Using the Measure Button

Most tests have a Measure button within the dialogue box.

It is included there to allow you to quickly measure the value from a sample transformer with the AT5600 and to set the limits for that test.

### Hardware Connections for Using the Measure Button

Before attempting to use the Measure button:

1. Make sure you have connected your tester to a suitable comm port on your PC. This can be RS232 to AUX port or direct USB.
2. Set up the comm port on the PC. From the Top-Level menu, select **Setup >Communications**.
3. Fit the appropriate fixture to the tester.
4. Have available both a sample transformer, and possibly a shorting header if you wish to add tests to the program for which you will be applying short-circuit compensation.

### Example of Using the Measure Button with the LS test

LS - Winding Inductance (Series Circuit) - is one of the tests where the actual measurement may be obtained by using the Measure button. The following is an example using the Measure button.

Initially select the LS test in the normal way by double-clicking with the mouse in the Available Tests list.

In the LS test dialogue box:

1. Enter the terminal names in the normal way.
2. Select the integration you require if different from the default setting of Medium. See AT5600 manual 7.3 Explanation of Integration.
3. In the Test Parameters section, enter the Signal and the Frequency fill-in boxes, see Chapter 7 - Tests and test conditions for suitable values for the specific test.

Now, using the mouse, click on the Measure button.

Because the LS test is one where short-circuit compensation could be applied, you will then see the following message:



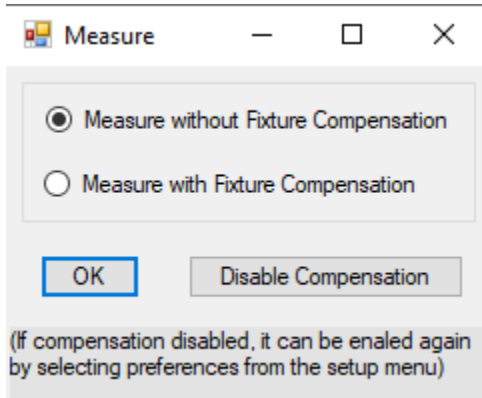

If you click on 'OK' with 'Measure with Fixture Compensation' selected, then there will be additional messages, which depend on whether the test requires short- and / or open-circuit compensation. In this case, the LS test requires both compensations, so the following dialogue box will be shown:

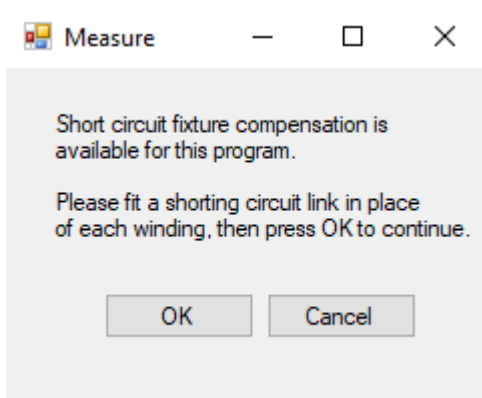

Fit the required short-circuit header and click on 'OK'.

The Editor will now command the tester to perform the Compensation for the required test (in this case LS). The tester will then store the 'zero' value and subtract it from the next result returned for the test.

Next the Open Circuit compensation will be applied.

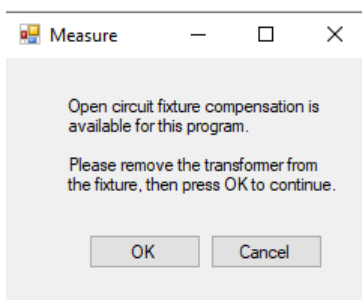

Assuming no errors, when the tester has finished the compensation measurements, you will be prompted to remove the shorting links, and fit the sample transformer:

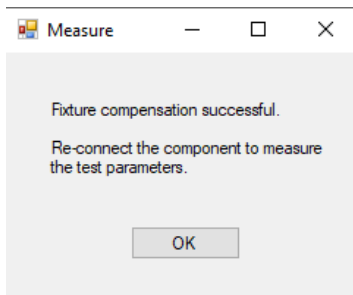

After you have clicked on the 'OK' button, the tester will be commanded to make its measurements. When the measurements have finished, the display will return to the dialogue box for the LS test with the NOMINAL set as the measured inductance:

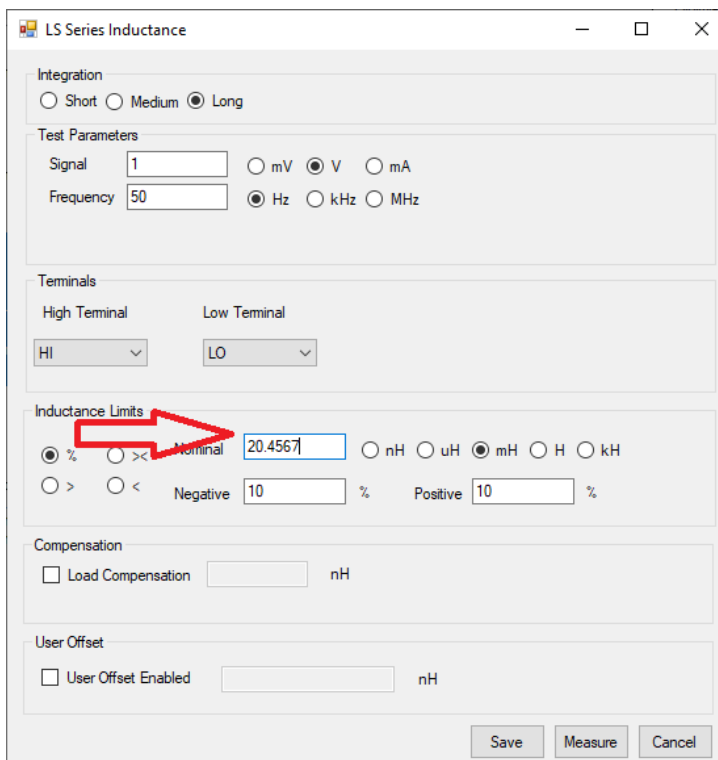

From this point, it is very easy for you to complete the dialogue box by simply entering the values you require for the Negative and Positive percentage limits, or to adjust the nominal value again.

## 2.4.11. Run Your Program

Typically, in production use, your program would be downloaded to AT Series Tester from the Server, which is a PC resident software package.

However, before you transfer your program to your defined “AT Server programs folder”, you should always verify it by running it on an actual transformer.

The Editor software will enable you to download a program directly to the tester, and to execute it, and return the results to the PC.

1. Set up the Comm Port on the PC.

From the Top-Level menu, select **Setup > Communications**.

In the dialogue box, select the PC communications port which is connected to the tester.

2. Fit the appropriate fixture to the tester and plug in the specimen transformer.  
You are now ready to download and run your test program.

3. From the Top Level menu bar, select **Tester > Download Program**

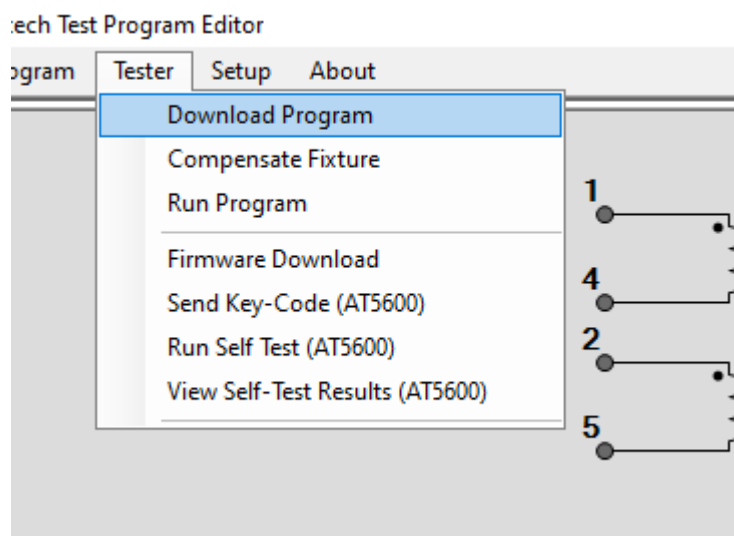

The Editor will now download the test program to the tester.

After a few seconds, you should see a message to say that the Download was successful.

4. Again, from the Top Level menu bar, select **Tester > Run Program**

The test program will now begin execution. When it is finished, you will see a dialogue box containing the results of the test.

ID	Test Type	Result	Unit	Pass/Fail	Sub Type	DSP Status	Polarity	Sign	PolPassFail	Time
1	R	19.29130	mOhm	PASS		0000				0.53
2	R	14.74410	mOhm	PASS		0000				2.14
3	LS	20.01300	mH	PASS		0000				1.09
4	TR	2.00225		PASS		0000	POL	+	PASS	4.43
OVERALL			PASS						8.18	

From the results, you should be able to see any tests where there may be problems.

Return to the Program Editor to make the necessary changes and then download the program again and run the corrected version.

Continue in this way until you are satisfied that the program is correct, before archiving it for use in production.

### Test times.

The first proper test run after compensation, on either via the Editor or Server, may take longer to execute than the subsequent 2<sup>nd</sup> 3<sup>rd</sup> 4<sup>th</sup>.... runs.

This is because the AT5600 learns the best generator settings to quickly trim to your requested test conditions.

You should find that subsequent runs can be 200-300% faster than the first run, and this is expected and normal.

In the event of a later valid failure of a part, the next run will also be a “learning” run, and again may be slower, after which the speed will increase again.

### DSP Status Codes

The code at the end of each result line should normally be zero; any other code signifies that an error occurred in the measurement. See AT5600 manual 9.1.2.

From this dialog box the following 4 options are available

### 1 Re-Run Test

This will run the program on the unit again, allowing you to check for repeatability of results.

Please note that (unlike the old Editor) the results window is resizable to allow you to get a better overview of multiple runs.

### 2 Print

This in turn allows two options.

#### 2a, Print Result

Print the results to a printer connected to PC (NOT the AT tester) (or PC PDF writer)

DATE TIME: 2020-08-03 16:08:34									
PART NUMBER: 0707									
1	R	443.22200	mOhm	PASS	0000				
2	R	452.40000	mOhm	PASS	0000				
3	LS	4.19167	mH	PASS	0000				
4	TR	1.00502		PASS	0000	POL	+	PASS	
5	C	80.16890	pF	FAIL	0000				
6	LL	822.24600	nH	FAIL	0000				
7	HPAC	22.21710	uA	PASS	0000				
	OVERALL		FAIL						3.23
1	R	442.59200	mOhm	PASS	0000				
2	R	451.43800	mOhm	PASS	0000				
3	LS	4.18543	mH	PASS	0000				
4	TR	1.00577		PASS	0000	POL	+	PASS	
5	C	80.16590	pF	FAIL	0000				
6	LL	822.24100	nH	FAIL	0000				
7	HPAC	22.22010	uA	PASS	0000				
	OVERALL		FAIL						3.21

**2b, Print program and result.**

Print the result AND the test program containing the conditions to a PC printer or PDF writer.

General Tests	
<b>1. Winding Resistance</b>	
Integration: Long	
High Terminal: 1	Low Terminal: 3
Maximum Value: 600.00 mOhm	
Result	442.78900 mOhm
P/F	PASS
Stat	0000
-----	
<b>2. Winding Resistance</b>	
Integration: Long	
High Terminal: 6	Low Terminal: 4
Maximum Value: 600.00 mOhm	
Result	452.29100 mOhm
P/F	PASS
Stat	0000
-----	

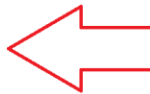

**3, Save**

Save the results to a CSV file, which can then be opened in EXCEL.

	A	B	C	D	E	F	G	H	I	J	K
1	AT Editor Test Results										
2	DATE:	03-Aug-20									
3	TIME:	4:06:17 PM									
4	PART NUMBER:	707									
5	ID	TEST	RESULT	UNITS	PASS/FAIL	STATUS	POL +/-	RESULT	TIME		
6		1 R	443.222	mOhm	PASS		0		0.26		
7		2 R	452.4	mOhm	PASS		0		0.15		
8		3 LS	4.19167	mH	PASS		0		0.11		
9		4 TR	1.00502		PASS		0 POL +	PASS	0.32		
10		5 C	80.1689	pF	FAIL		0		0.2		
11		6 LL	822.246	nH	FAIL		0		1.03		
12		7 HPAC	22.2171	uA	PASS		0		1.16		
13		OVERALL			FAIL				3.23		
14											
15		1 R	442.592	mOhm	PASS		0		0.23		
16		2 R	451.438	mOhm	PASS		0		0.15		
17		3 LS	4.18543	mH	PASS		0		0.12		
18		4 TR	1.00577		PASS		0 POL +	PASS	0.31		
19		5 C	80.1659	pF	FAIL		0		0.2		
20		6 LL	822.241	nH	FAIL		0		1.03		
21		7 HPAC	22.2201	uA	PASS		0		1.17		
22		OVERALL			FAIL				3.21		
23											
24											

**4, Close**

Close the result window and allows you to edit the program.

## 2.4.12. Compensation

When measuring small values of resistance, inductance or capacitance, the effects of the fixture can add significant errors to the results.

To allow you to make more accurate measurements, the AT Series Testers have built-in firmware to compensate for the fixture effects.

From the top-level menu bar, select **Tester > Compensate Fixture**.

Most programs will contain at least one test where compensation can be applied.

First, Short circuit compensation will be applied.

This requires a fixture where every used node (both source and measure) is shorted together.

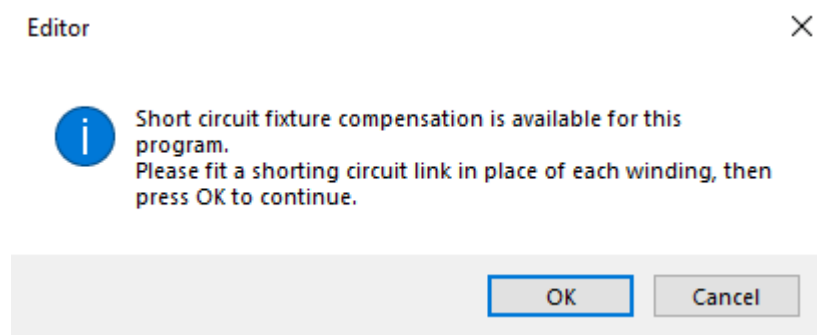

Then Open Circuit compensation will be applied. This requires a fixture with no UUT fitted, but with every used Source / Measure pair shorted together.

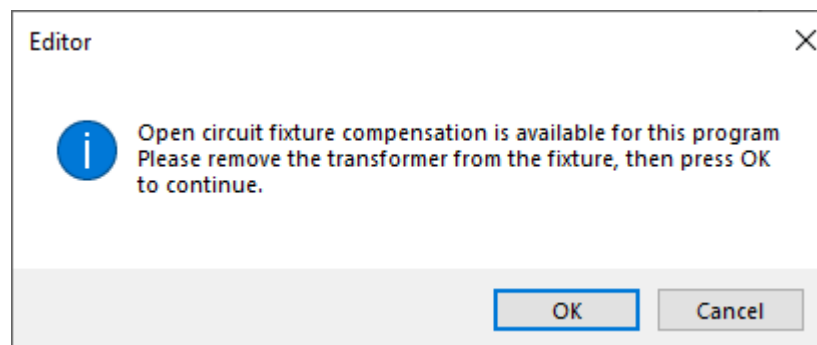

After you have clicked on the 'OK' button at either of the messages, the tester will be commanded to make the compensation measurements for your test program.

If errors are encountered, such as a shorting link is not fitted, the editor will display the appropriate warning message, and allow you either to try again, or to cancel the compensation.

AT5600 ONLY When the compensation measurements have been successfully completed, the compensation values for each test in the program will be stored inside the tester.

Any subsequent measurements (started as described above by clicking on Tester - Run Program) will return compensated results to the Editor.

To determine whether it is necessary to compensate or not, simply try it. If any of the results change significantly, then it should be done.

**REMEMBER:** Whenever you make changes to the program, the compensation results in the tester will no longer be valid.

Make sure to compensate again each time you download a test program to an AT Series Tester if you have changed the program.

On download to the tester, the front panel will display the compensations status, even if you are running the program from the editor, so you can check if saved compensation is applied for your current test program.



## 2.4.13. Hints and Tips

The following is a list of points that should be remembered when you are creating your test programs.

### 2.4.13.1. Schematic

Create your schematic first.

When you are creating your test programs, you should work in the following order:

1. Initially, create the schematic.
2. Then, set up the program options.
3. Finally, create the list of tests that make up the program.

Note: If you make any changes to the schematic after you have created the list of tests, then some tests may be inadvertently deleted.

Examples where this may happen are deleting a winding or a terminal or renaming a terminal.

### 2.4.13.2. Test Order

The actual tests used in the program are of course dependent on the type of transformer to be tested, and the number of parameters you have chosen to test. You are free to program them in any order you wish.

However, it is recommended that you generally do the tests in the following order:

**Continuity/ DC resistance.** To detect a transformer not correctly plugged into the test fixture, and any open circuit windings.

**Primary inductance or magnetizing current.** To detect faulty core material, and the wrong number of primary turns.

**Turns ratios or open circuit voltages.** To detect any windings with the wrong number of turns.

**Class D tests (MAGI / VOC / WATT / STRW / ILK)** 1-270 V AC , 0-2A for testing typically line transformers

**AC interface tests (MAGC, VOCX, WATX, STRX)** for 270-600V, 50mA-6A testing using the AC interface

**DC1000 tests (LSBX, LPBX, ZBX)** for checking core saturation behaviour under DC Current 0-25 Amps

**Isolation tests such as Insulation Resistance. (IR, SURG )** To detect poor interwinding isolation where safety is not an issue, for example between two secondary windings.

**Safety tests such as Hi-Pot. (HPAC HPDC )** To detect poor interwinding isolation; but this time where safety is an issue, for example, from a primary winding to a secondary winding on a mains isolation transformer.

In the above list, items will depend on the type of transformer:

For ferrite cored transformers operating at frequencies higher than 1kHz, it is preferable to measure the primary inductance and the turns ratios between windings.

For iron cored transformers operating at the 50 or 60Hz line frequency, where normal operation extends to the point of core saturation, magnetizing current and open circuit voltage measurement are normally the preferred tests.

**Use test limits which are as wide as possible.**

For example, if you are testing the turns ratio between windings where the actual number of turns on one of the windings is only 10, specify limits of  $\pm 5\%$  (which is equivalent to half a turn).

Remember that TR turn ration is “turns ratio by Voltage” and so the output voltage will be affected by any natural losses in the transformer.

Hence you cannot always expect the ratio to be the exact mathematical value of (#Turns primary) / (#Turns Secondary)

**Make use of the Measure button.**

For many tests, the dialogue box for the test contains a button labelled ‘Measure’.

If, when you are creating your test program, you have a tester connected to your PC, fitted with the appropriate test fixture containing a specimen transformer, clicking on the Measure button will signal the tester to measure the actual parameter of the test. The result will be returned to the PC, and the Editor will insert it as the ‘nominal value’ in the limits section of the test dialogue box.

This is often the best way to find the value for some of the parameters which you may wish to test, but which do not appear on the actual transformer design documents.

### Run, Check, Save, File names

Finally, download and run the program from the Editor as a completed “top to bottom” program run, to make sure the results are what you expect before you use it in production.

You should also use open and short compensation here (can be applied using the “Editor>Tester >compensate fixture” menu option

The test program can be saved using the FILE/SAVE or SAVE AS feature of the editor.

The resulting \*.ATP program file can then be moved to your chosen program storage folder on the PC, or a network drive, for use by the AT SERVER.

Program File Names can be up to 20 characters long and should only contain the following characters.

Numbers	0-9
Letters	A-Z ( uppercase only)
+	plus
-	minus
(	Open bracket
)	Close bracket
.	dot / period
,	comma
<space>	space

### 2.4.13.3. Test Grouping

Tests can be programmed in any order you wish, and the results for each individual test will be independent of where they are in the program.

However, the AT5600 has 6 different power sources, and to get the best speed execution time we recommend that tests are grouped using the following table. This minimizes change over time between the different sources.

Tests in the same group can be run in any order, However, Further speed increases can be achieved within a test type group by keeping tests that share the same conditions -i.e. the same

Energized HI LO nodes and  
Voltage and  
Frequency .

For example,

LS RLP Z **HPAC** - would execute faster than  
LS **HPAC** RLP Z - as HPAC is in a different grouping from the other 3

Or

R RLS **MAGI VOC** - would execute faster than  
R **MAGI** RLS **VOC** - as MAGI and VOC are in the same group.

Best Speed Grouping and order in program	Test	Test Description
1	CTY	Continuity
1	R	DC Winding Resistance
1	R2	Resistance Match
2	LS	Series Inductance
2	LP	Parallel Inductance
2	LL	Leakage Inductance
2	RLS	Equivalent Series Resistance
2	RLP	Equivalent Parallel Resistance
2	L2	Inductance Match
2	ANGL	Impedance Phase Angle
2	D	Dissipation Factor
2	QL	Quality Factor
2	Z	Impedance
2	C	Interwinding Capacitance
2	C2	Capacitance Match
2	LVOC	Low Voltage Open Circuit
2	PHAS	Interwinding Phase Angle

**CHAPTER 16 - CHANGE LOG**

2	TR	Turns Ratio
2	TRL	Turns Ratio by Inductance
3	ILOS	Insertion Loss
3	LBAL	Longitudinal Balance
3	RESP	Frequency Response
3	RLOS	Return Loss
3	GBAL	General Longitudinal Balance
4	LPB	Parallel Inductance with Bias
4	LSB	Series Inductance with Bias
4	ZB	Impedance with bias
5	MAGI	Magnetizing Current
5	STRW	Stress Wattage
5	VOC	Open Circuit Voltage
5	WATT	Wattage
5	ILK	Leakage Current
5	PWRF	Power factor
6	MAGX	Magnetizing Current (AC Interface)
6	STRX	Stress Wattage (AC Interface)
6	VOCX	Open Circuit Voltage (AC Interface)
6	WATX	Wattage (AC Interface)
7	LPBX	Parallel Inductance with Bias (DC1000)
7	LSBX	Series Inductance with Bias (DC1000)
7	ZBX	Impedance with Bias (DC1000)
8	IR	Insulation Resistance
8	SURG	Surge Stress
9	HPAC	Hi-Pot AC
9	HPDC	Hi-Pot DC

## 2.4.14. Program Options Batch View

This NEW feature allows you to quickly examine the test options for ALL the programs in a chosen folder, so that you can rapidly review these options and make amendments to your test program library.

To use this feature.

1, select **Program Options Batch View** from the **Part** menu

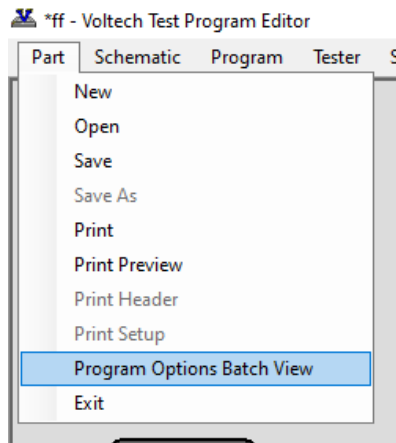

2, Navigate to the **folder** you wish to examine.

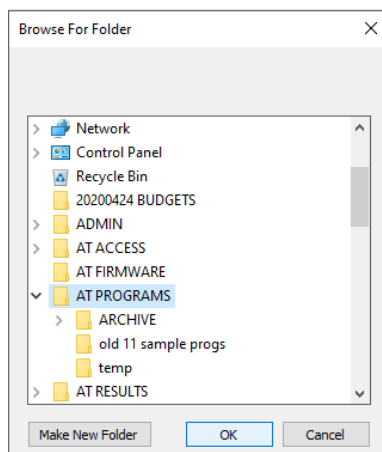

3, The following window will open and display the summary for ATP programs contained within the folder.

Program Options Batch View

File Name	Part Name	Fixture	Printing	Kelvin	Operator	Batch	Serial	Stop on Fail	Disable A
06 TCT40-01E07AB L.atp	06 TCT40-01E07AB L	TRIAD TCT40-01E07ABM			ALL				
07 MURTA 786 L.atp	07 MURTA 786 L	FIXTURE 289			ALL				
08 POWER PCV256408L L.atp	08 POWER PCV256408L L	FIXTURE 289			ALL				
09 POE 7491199212 L.atp	09 POE 7491199212 L	FIXTURE 289			ALL				
10 CT100-5 L.atp	10 CT100-5 L	FIXTURE 290			ALL	YES			
11 ccf1 210607 L.atp	11 CCFL 210607 L	FIXTURE 290			ALL				
111.atp	111	1							
220-054 Toroidal A.atp	220-054 TOROIDAL A	220-053			ALL				
220-054 Toroidal D.atp	220-054 TOROIDAL D	220-053			ALL				
220-054 Toroidal K.atp	220-054 TOROIDAL K	220-053			ALL				
220-054 Toroidal P.atp	220-054 TOROIDAL P	220-053			ALL				
220-054 Toroidal.atp	220-054 TOROIDAL	220-053			ALL	YES	YES		
300mohm.atp	300MOHM	RSWEEP 109							
91-295 SN 15.atp	91-295 SN 15	91-295 SN15			ALL	YES	YES		
ATI B8273 L.atp	ATI B8273 L	FIXTURE 290			ALL		YES		
DIAGNOSTIC-HP.atp	DIAGNOSTIC-HP	91-186							
DIAGNOSTIC.atp	DIAGNOSTIC	91-186							
rr.atp	RRR	CT16-15954			ALL				
mrr.atp	RRRRR	FIXTURE 290			ALL				
RSHORT.atp	RSHORT	R SWEEP ID109				YES	YES		
SOF.atp	SOF	GFHDG						YES	

Refresh Export To CSV Exit

4, Clicking on any column heading will **SORT** all data by that column.

Clicking again will **reverse sort**.

5, This report can then be exported or left open (or moved to another monitor), allowing you to open and update the programs you want to give you quicker management of your test program library.

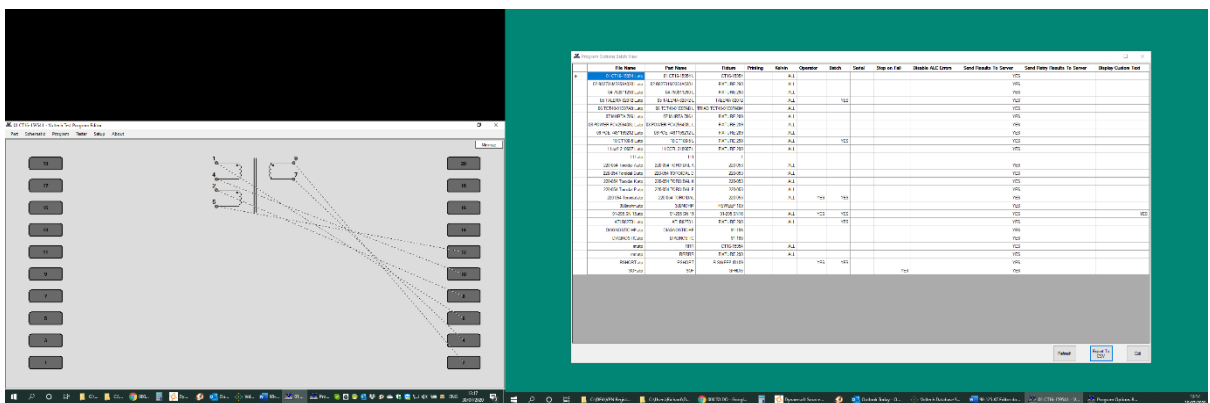

Once you have performed your edits, you can use the **REFRESH** button to reload the summary information and check your changes.

## 6, Data contained in the Program Options Batch View

Most of the column headings should be familiar to you as a summary overview of the options usually set in the Program>options menu. However, it is worth discussing two specific ones that are not obvious.

### **“Diff” (Third Column)**

This is “X” when the WINDOWS FILE NAME of the ATP program does not match the PROGRAM NAME stored in the program.

This is a legacy of Win 95 days, when file names were restricted to be 8.3 format. With the advent of WIN 98 and later, file names could be longer.

The WINDOWS FILE NAME is the PC representation of the program as you see it. The PROGRAM NAME is used on the AT display and results.

This mismatch can also be caused by users renaming ATP files in windows, but not realizing that the PROGRAM NAME contained within the ATP is not updated by this.

### **How to correct any ATPs showing “Diff”**

You may have some old programs that are still not in alignment but opening them and re-saving them will remove this discrepancy. The report can be rerun or refreshed to then remove the X from any you have corrected.

### **“Legacy version” (last column)**

Certain features such as CUSTOM TEXT, and some test options were only introduced in V3. xx of the editors

Some customers may still have ATP programs that they have never changed since being written in V1. xx or V2.xx of the Editor.

The New dot NET Editor, server and AT5600 only supports programs written in V3.x, so this column helps quickly identify any programs still in the old format.

### **How to correct any ATPs showing “Legacy Version”**

If you have any programs that show up as legacy version, then they can be easily corrected by.

A, opening in V3.56 of the editor (you can have V3.x and V4.x installed at the same time on one PC as they are independent of each other)

B, making some small cosmetic change to the contents.

This can be as simple as going to Program > Options, and enter in



something in CUSTOM TEXT dialog. This change will force and update and a re-write of the program to the latest version.

C, SAVE the program again.

D, return to the dotNET Editor and rerun the “Program Options Batch View” report. The “YES” in Legacy version” will have cleared

### **2.4.15. Get Diagnostic Info**

This is a new feature only available on the dotNET At Editor and only when using the AT5600.

When a program (ATP file) is downloaded to the AT5600, the program is compiled on the unit, and when compensation and run on your transformer, the internal settings (relay settings, Voltage, and current ranges ) are optimised and stored for the rest of the batch.

The “Get Diagnostic info” option allows you to extract the compiled program back from the AT5600 and save it to the PC as an XML file.

This file is of no practical use to a user but can help Voltech Applications Support and Engineering investigate any specific test issues you may encounter.

## 2.5. Programming Specific Tests

This section describes in more detail how to fill in the data for the dialogue boxes for each of the tests available for your AT5600.

Most of the following tests also allow two optional methods to manipulate the results. To avoid repetition, these are covered here at the beginning rather than repeated in every following individual test section.

### 2.5.1. Load Compensation

Load Compensation allows you to apply a third type of compensation in addition to the standard OPEN and SHORT compensation. It was previously only available for the LL and SURGE tests on the AT5600 but is now available on all tests.

This allows you to scale the raw result from the AT5600 to match an externally measured number.

This can be helpful in cases of

A very small signal test, or very small measurements at the bottom of the measurement range, e.g., 0-10 milli ohms for resistance.

B tests where the result is within the published unit spec, and stable, but you wish to normalize the number against an external piece of test equipment.

C certain cases where you wish to get better consistency of results between AT3600 and AT5600

In all cases the principle is the same.

1 Measure one golden transfer part using your reference meter to get the result of that part.

2 Enter this reading into the load compensation.

3 Load the test program and compensate as normal for OC and SC. When asked to Load compensate, then fit your golden transfer part that you have measured when prompted. The unit will "learn" this reading to be your entered measurement and will scale the results of all subsequent parts tested to be in line with the transfer standard

## EXAMPLE

Consider the case of a SURGE test.

This can vary between different AT3600s and AT5600s as the measurement is a characteristic number of the area of the surge impulse which is dependent on BOTH the UUT you are testing AND the internal capacitors of the AT being used.

Assume in this case.

AT3600 reads 200 mVsec.

AT5600 reads 235 mVsec.

To scale the measurement on the AT5600 to match the AT3600 results, enable the load compensation and enter the expected result of 200 mVsec.

R Winding Resistance

Integration

Short  Medium  Long

Terminals

High Terminal: 1

Low Terminal: 3

Resistance Limits

%  ><

>  < Maximum: 200

mOhm  Ohm  kOhm  MOhm

Compensation

Load Compensation

User Offset

User Offset Enabled: -20 mOhm

Save Measure Cancel

It's important to remember that this load compensation scaling factor is applied BEFORE the pass-fail judgment is made on your chosen limits,

## 2.5.2. User Offset

All test results can also have a user chosen offset added or removed from the raw results before your pass / fail limits are applied.

This feature is available on the AT5600, AT3600 and ATi

This can be helpful where you have fixed and repeatable parasitic fixturing or wiring effects that you cannot easily remove from your test results, even with SC and OC compensation applied.

### Example

The AT reads 65 milliohms, but you have independently measured the part, and know the correct result without fixturing or wirings to be 45 milliohms.

To use this feature, click the “User Offset Enabled” box on the test and enter a positive or negative number, (in this case “-20” milliohms) depending on how you wish the offset to be applied.

The screenshot shows the 'R Winding Resistance' dialog box. The 'User Offset' section is highlighted with a green rounded rectangle. It contains a checked checkbox labeled 'User Offset Enabled' and a text input field containing the value '-20' followed by the unit 'mOhm'. Other sections include 'Integration' (Short, Medium, Long), 'Terminals' (High Terminal: 1, Low Terminal: 3), 'Resistance Limits' (Maximum: 200, mOhm selected), and 'Compensation' (Load Compensation checkbox).

Again, it's important to remember that this load compensation scaling factor is applied BEFORE the pass-fail judgment is made on your chosen limits,

### 2.5.3. CTY - Continuity

The continuity test can be placed as the first test in the program to check that the transformer has been inserted correctly into the test fixture.

The test checks that every winding has a resistance less than a user specified limit, the same limit being applied to all windings.

The CTY test is an alternative to using an R (Winding Resistance) test on each winding separately. The CTY test has the advantage of speed of execution; but with the R test, individual limits can be applied to each winding, to give confidence, for example, that the correct wire gauge has been used.

On selecting 'CTY - Continuity' from the available tests window, the following dialogue box will be displayed:

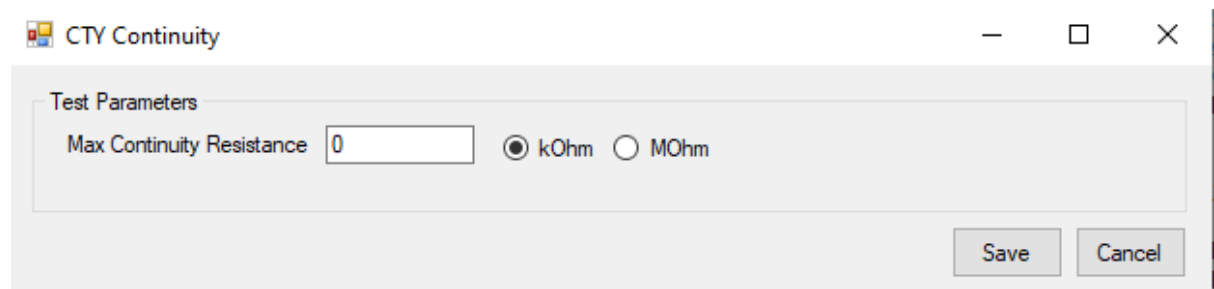

To program the test:

Enter the maximum resistance limit.

Remember that there is only one limit, and the same value will be applied to all windings.

If all the windings on your transformer have small resistance values, then choose the value of 10k $\Omega$ , to give the quickest test execution.

If any winding has a resistance greater than 10k $\Omega$ , then choose a value bigger than that expected for the winding with the largest resistance.

Select OK.

The test specification will then be displayed in the program window.

### 2.5.4. R - Winding Resistance

To check that the resistance of a winding is correct, the AT5600 applies a DC test signal to the selected winding. It then measures both the current through and the voltage across the winding and calculates the resistance.

On selecting 'R Winding Resistance' from the available tests window, a dialogue box will be displayed.

**R Winding Resistance**

Integration  
 Short  Medium  Long

Terminals  
 High Terminal:   
 Low Terminal:

Resistance Limits  
 %  >< Minimum:   mOhm  Ohm  kOhm  MOhm  
 >  < Maximum:   mOhm  Ohm  kOhm  MOhm

Compensation  
 Load Compensation  mOhm

User Offset  
 User Offset Enabled  mOhm

Save Measure Cancel

To program the test:

Select the integration time you require. 'Medium' is the default setting. 'long' will give more stable readings (for tighter limits) at the expense of an increased test time, and 'short' will test at the maximum speed but may give a slightly noisier reading. See At5600 manual 7.3 Explanation of Integration.

Enter the terminal names between which the resistance is to be measured.

Select the type of limits you require and enter the values.

- % Enter a nominal value and then the limits as + / - % values.
- >< Enter minimum and maximum values.
- > Enter just a minimum value.
- < Enter just a maximum value.

Select OK.

The test specification will then be displayed in the program window.



### 2.5.5. RLS or RLP - Equivalent Series or Parallel Resistance

The equivalent series or parallel resistance is obtained from a measurement of the complex impedance.

An AC voltage is applied across the selected winding. The voltage across and current through the winding are then measured using harmonic analysis. The measured voltage is divided by the current to obtain a complex impedance and the equivalent series or parallel resistance calculated.

Select either 'RLS Equivalent Series Resistance' or 'RLP Equivalent Parallel Resistance' from the Available Tests window, to display:

RLS Equivalent Series Resistance

Integration  
 Short  Medium  Long

Test Parameters  
 Signal   mV  V  mA  
 Frequency   Hz  kHz  MHz

Terminals  
 High Terminal  Low Terminal

Resistance Limits  
 %  >=  <=  >  <  
 Minimum   mOhm  Ohm  kOhm  MOhm  
 Maximum   mOhm  Ohm  kOhm  MOhm

Compensation  
 Load Compensation  mOhm

User Offset  
 User Offset Enabled  mOhm

Save Measure Cancel

To program the test:

Enter the signal and frequency required for the test.

Note that the signal is normally entered as a voltage by selecting the 'mV' or 'V' button; but you may optionally enter it as a current by selecting the 'mA' button.

(If in doubt, refer to AT5600 manual AT5600 manual Ch 7 - 'Test Conditions', which lists recommended test conditions based on the values of winding inductance.)

Select the integration time you require.

'Medium' is the default setting. 'Long' will give more stable readings (for tighter limits) at the expense of an increased test time, and 'Short' will test at the maximum speed, but may give a slightly noisier reading

Enter the terminal names for the selected winding.

Select the type of limits you require and enter the values.

% Enter a nominal value and then the limits as + / - % values.

>< Enter minimum and maximum values.

> Enter just a minimum value.

< Enter just a maximum value.

Select OK.

The test specification will then be displayed in the program window.

### 2.5.6. LS or LP - Winding Inductance (Series or Parallel Circuit)

The inductance of a transformer winding may be tested using series or parallel equivalent circuit models.

An AC voltage is applied across the selected winding. The voltage across and current through the winding are then measured using harmonic analysis.

The measured voltage is divided by the current to obtain a complex impedance and the inductance is calculated.

On selecting 'LS Inductance (series cct)' or 'LP Inductance (parallel cct)' from the Available Tests window, a dialogue box will be displayed.

**LS Series Inductance**

Integration  
 Short  Medium  Long

Test Parameters  
 Signal   mV  V  mA  
 Frequency   Hz  kHz  MHz

Terminals  
 High Terminal  Low Terminal

Inductance Limits  
 %  >=  <=  >  <  
 Minimum   nH  uH  mH  H  kH  
 Maximum   nH  uH  mH  H  kH

Compensation  
 Load Compensation  nH

User Offset  
 User Offset Enabled  nH

To program the test:

Enter the signal and frequency required for the test. Note that the signal is normally entered as a voltage by selecting the 'mV' or 'V' button; but you may optionally enter it as a current by selecting the 'mA' button. (Refer to AT5600 manual Ch 7 - 'Test Conditions', which lists recommended test conditions for different values of inductance.)

Select the integration time you require. 'Medium' is the default setting. 'Long' will give more stable readings (for tighter limits) at the expense of an increased test time, and 'Short' will test at the maximum speed, but may give a slightly noisier reading. See AT5600 manual 7.3 Explanation of Integration.

Enter the terminal names between which the inductance will be measured.

Select the type of limits you require and enter the values.

- % Enter a nominal value and then the limits as + / - % values.
- >< Enter minimum and maximum values.
- > Enter just a minimum value.
- < Enter just a maximum value.

Note: The Measure button may be used here as outlined in section 2.4.10.

Select OK.

The test specification will then be displayed in the program window.

### 2.5.7. LSB or LPB - Inductance with Bias (Series or Parallel Circuit)

The inductance of a transformer winding when a bias current is flowing may be tested using series or parallel equivalent circuit models.

Initially the (DC) bias current is set up and allowed to stabilize.

An AC voltage is applied across the selected winding; the voltage across and current through the winding are then measured using harmonic analysis.

The measured voltage is divided by the current to obtain a complex impedance and the inductance is calculated.

On selecting 'LSB Inductance with Bias (Series cct)' or 'LPB Inductance with Bias (Parallel cct)' from the Available Tests window, a dialogue box will be displayed.

LSB Series Inductance with Bias

Integration  
 Short  Medium  Long

Test Parameters  
 Signal   mV  V  mA  
 Frequency   Hz  kHz  MHz  
 Bias Current  mA

Terminals  
 High Terminal  Low Terminal

Inductance Limits  
 %  >=  <=  >  <  
 Minimum   nH  uH  mH  H  kH  
 Maximum   nH  uH  mH  H  kH

Compensation  
 Load Compensation  nH

User Offset  
 User Offset Enabled  nH

Save Measure Cancel

To program the test:

Enter the signal, frequency and bias current required for the test.

Note: The signal is normally entered as a voltage by selecting the 'mV' or 'V' button; but you may optionally enter it as a current by selecting the 'mA' button.

(Refer to AT5600 manual Ch 7 - 'Test Conditions', which lists recommended test conditions for different values of inductance.)

Select the integration time you require.

'Medium' is the default setting. 'Long' will give more stable readings (for tighter limits) at the expense of an increased test time, and 'Short' will test at the maximum speed but may give a slightly noisier reading. See AT5600 manual 7.3 Explanation of Integration.

Enter the terminal names between which the inductance will be measured.

Select the type of limits you require and enter the values.

% Enter a nominal value and then the limits as + / - % values.

>< Enter minimum and maximum values.

> Enter just a minimum value.

< Enter just a maximum value.

Note: The Measure button may be used here as outlined in section 2.4.10.

Select OK.

The test specification will then be displayed in the program window.

## 2.5.8. QL - Quality Factor

To test for Q factor, an AC voltage is applied across the selected winding.

The voltage across and current through the winding are then measured using harmonic analysis.

The measured voltage is divided by the current to obtain a complex impedance, from which the Q factor is calculated.

On selecting 'QL Q Factor' from the Available Tests window, a dialogue box will be displayed.

QL Q Factor

Integration  
 Short  Medium  Long

Test Parameters  
 Signal   mV  V  mA  
 Frequency   Hz  kHz  MHz

Terminals  
 High Terminal  Low Terminal

Q Factor Limits  
 %  >< Minimum   
 >  < Maximum

Compensation  
 Load Compensation

User Offset  
 User Offset Enabled

Save Measure Cancel

To program the test:

Enter the signal and frequency required for the test.

Note that the signal is normally entered as a voltage by selecting the 'mV' or 'V'; but you may optionally enter it as a current by selecting the 'mA' button. (If in doubt, refer to AT5600 manual Ch 7 - 'Test Conditions', which lists recommended test conditions based on the values of winding inductance).

Select the integration time you require. 'Medium' is the default setting. 'Long' will give more stable readings (for tighter limits) at the expense of an increased test time, and 'Short' will test at the maximum speed but may give a slightly noisier reading. See AT5600 manual 7.3 Explanation of Integration.

Enter the high and low terminal names..

Select the type of limits you require and enter the values.

- % Enter a nominal value and then the limits as + / - % values.
- >< Enter minimum and maximum values.
- > Enter just a minimum value.
- < Enter just a maximum value.

Note: The Measure button may be used here as outlined in section 2.4.10.

Select OK.

The test specification will then be displayed in the program window.



### 2.5.9. D - Dissipation Factor or Tan $\delta$

To measure dissipation factor, the tester applies an AC voltage across the selected winding and measures the voltage across and the current through the winding.

Using harmonic analysis, the measured voltage is divided by the current to obtain a complex impedance from which the dissipation factor is obtained.

To program the test:

Choosing the test signal and frequency

For optimum accuracy and performance, use the test conditions chosen for capacitance in a later section of this chapter.

Choose the integration period (normally 'Medium'). 'Medium' is the default setting. 'long' will give more stable readings (for tighter limits) at the expense of an increased test time, and 'short' will test at the maximum speed but may give a slightly noisier reading. See AT5600 manual 7.3 Explanation of Integration.

Enter the Terminals to measure.

Choosing the test limits

- % A nominal value together with + and - percentage limits.
- >< Minimum and maximum values
- > A minimum value only
- < A maximum value only

Note: The Measure button may be used here as outlined in section 2.4.10.

Select OK.

The test specification will then be displayed in the program window.

### 2.5.10. LL - Leakage Inductance

The Leakage Inductance for a transformer is tested by measuring the inductance of a 'primary' winding when one or more 'secondary' windings have short-circuited applied.

Select 'LL Leakage Inductance' from the available tests window, to display the following form fill-in dialogue boxes as appropriate.

**LL Leakage Inductance**

Integration  
 Short  Medium  Long

Test Parameters  
 Signal   uA  mA  mV  
 Frequency   Hz  kHz  MHz

Primary Terminals  
 High Terminal  Low Terminal

Secondary Terminals  
 High Terminal  Low Terminal

Additional Low Terminals  
 Available: 1, 2, 4, 5, 7, 9  
 Used:

Inductance Limits  
 %  >< Minimum   nH  uH  mH  H  kH  
 >  < Maximum   nH  uH  mH  H  kH

Compensation  
 Load Compensation  nH

User Offset  
 User Offset Enabled  nH

To program the test:

Enter the signal and frequency required for the test.

Note that the signal is normally entered as a current by selecting the 'uH' or 'mA' button; but you may optionally enter it as a voltage by selecting the 'mV' button. (Refer to AT5600 User Manual Ch7 - 'Test Conditions' if you are unsure of the voltage and frequency to use.)

Select the integration time you require. 'Medium' is the default setting. 'Long' will give more stable readings (for tighter limits) at the expense of an increased test time, and 'Short' will test at the maximum speed but may give a slightly noisier reading. See AT5600 manual 7.3 Explanation of Integration.

Select the high and low terminals of the coil to be energized (primary terminals).

Select the secondary high and low terminals. These terminals will be shorted out during the test.

Select any additional low terminals. if required

These terminals are also shorted out during the test, but they are not used in the compensation measurements. If only one secondary winding is to be shorted, then there will be no additional low terminals. If several windings are to be shorted, then the Secondary Terminals should be on the winding with the largest number of turns, and Additional Low terminals should be used for the rest.

Select the type of limits you require and enter the values.

% Enter a nominal value and then the limits as negative and positive percentage values.

>< Enter minimum and maximum values.

> Enter just a minimum value.

< Enter just a maximum value.

Note: The Measure button may be used here as outlined in section 2.4.10.

If required, enter the load compensation value as outlined in section 13.5.

Select whether a user offset is required and enter its value if applicable. This value will be added to the measured value to give the returned result.

Normally a user offset would not be required. However, for small values of leakage inductance ( $<1\mu\text{H}$ ) when there are several additional low terminals, it is not always possible during compensation for the tester to remove all the parasitic errors of the test fixture. In this case, the user offset may be required to fully remove the errors.

Select OK.

The test specification will then be displayed in the program window.

## 2.5.11. C - Interwinding Capacitance

Your AT5600 can test the capacitance present between windings, screens, and core.

Select 'C Interwinding Capacitance' from the list of available tests, to give the following dialogue box:

**C Interwinding Capacitance**

Integration  
 Short  Medium  Long

Test Parameters  
 Voltage   mV  V  
 Frequency   Hz  kHz  MHz

High Terminals  
 Available: 1, 2, 4, 5, 7, 9  
 Used:   
 Add -> <- Remove

Low Terminals  
 Available: 1, 2, 4, 5, 7, 9  
 Used:   
 Add -> <- Remove

Capacitance Limits  
 %  >< Minimum   pF  nF  uF  
 >  < Maximum   pF  nF  uF

Compensation  
 Load Compensation  pF

User Offset  
 User Offset Enabled  pF

Save Measure Cancel

To program the test:

Enter the voltage and frequency required for the test. (Refer to AT5600 manual Ch 7 - 'Test Conditions', which lists recommended test conditions for different values of capacitance.)

Select the limit integration time you require. 'Medium' is the default setting. 'Long' will give more stable readings (for tighter limits) at the expense of an increased test time, and 'Short' will test at the maximum speed but may give a slightly noisier reading. See AT5600 manual 7.3 Explanation of Integration.

Enter the terminal names for the High and Low Terminals.

Select the type of limits you require and enter the values.

- % Enter a nominal value and then the limits as + / - % values.
- >< Enter minimum and maximum values.
- > Enter just a minimum value.
- < Enter just a maximum value.

Note: The Measure button may be used here as outlined in section 2.4.10.

Select OK. The test specification will then be displayed in the program window.

## 2.5.12. TR - Turns Ratio

You may program the AT5600 Tester to test the turns ratio between one winding and any other.

To measure turns ratio, a test source voltage is applied to one winding, the energized winding, and the voltages across two other windings (one of which may also be the energized winding) are measured using harmonic analysis. The turns ratio is measured by dividing one measured voltage by the other and making a compensation for the effects of winding resistance.

On selecting 'TR Turns Ratio' from the available tests window, a dialogue box will be displayed.

The screenshot shows a dialog box titled "TR Turns Ratio" with the following sections and controls:

- Integration:** Radio buttons for Short, Medium (selected), and Long.
- Test Parameters:**
  - Voltage: Input field with "0", radio buttons for mV (selected) and V.
  - Frequency: Input field with "0", radio buttons for Hz (selected), kHz, and MHz.
- Energised Terminals:** Two dropdown menus for High Terminal and Low Terminal.
- Primary Terminals:** Two dropdown menus for High Terminal and Low Terminal.
- Secondary Terminals:** Two dropdown menus for High Terminal and Low Terminal.
- Ratio Limits:**
  - Radio button for % (selected) with fields for Primary: Secondary (0) : (0).
  - Radio button for # with fields for Negative Error (0) % and Positive Error (0) %.
- Polarity:** Radio buttons for +ve, -ve, and No Test (selected).
- Compensation:** Check box for Load Compensation with an adjacent input field.
- User Offset:** Check box for User Offset Enabled with an adjacent input field.



To program the test:

In the fields provided, insert the voltage and frequency you require for the test (see AT5600 User Manual Ch7 - 'Test Conditions').

Select the integration time you require. 'Medium' is the default setting. 'Long' will give more stable readings (for tighter limits) at the expense of an increased test time, and 'Short' will test at the maximum speed but may give a slightly noisier reading. See AT5600 manual 7.3 Explanation of Integration.

Select the high and low terminals of the coil to be energized. (Click on the arrow to the right of the fill-in box and you will be provided with a choice of the available terminals. Click the required terminal.)

Normally, choose the energized winding to be the one with the highest number of turns. An exception to this rule can be made in the case when there are three separate windings, and you wish to check that two windings with the same number of turns are accurately 1:1; in this case, it is preferable to energize the third winding, even if it has fewer turns.

Similarly, select the high and low terminals of the primary and secondary windings.

In the case of a two-winding transformer, choose both the primary winding and the energized winding to be the one with the highest number of turns.

Select Ratio (%), or Turns (#) limits. And enter the required limits:

Ratio (%)

Enter the nominal Primary to Secondary ratio, together with the limits as positive and negative percentage values.

Turns (#)

In turns mode, you may set upper and lower limits on the primary and secondary windings. The transformer tester will then set limits on the turns ratio which are equal to the sum of these two errors,

e.g.:

primary      100 turns       $\pm 2$  turns

secondary    100 turns       $\pm 2$  turns

the tester will set the following limits on the ratio:

upper limit = 104/100

lower limit = 96/100

If you wish to set limits on only one winding, you must enter zero (0) as the limit for the other winding.

If required, the polarity of the test can be checked. Click on the expected polarity of the transformer turns, otherwise disable the test by selecting 'No Test'.

The Measure button may be used here as outlined in section 2.4.10.

Select OK. The test specification will be displayed in the program window on the screen.

## Choosing the test limits

The limits may be entered as:

### 1 A nominal value together a percentage tolerance (%)

Enter the nominal Primary to Secondary ratio, together with the limits as positive and negative percentage values.

### 2 An absolute number of turns (#)

When limits are set as +/- an absolute number of turns, the tester converts these limits to the % type in the following way:

$$= +/- (\text{Pri Limit}) / (\text{Pri Turns}) + (\text{Sec Limit}) / (\text{Sec Turns}) \quad \times 100\%$$

(You can see the exact result of this conversion by clicking on % limits in the Editor dialogue once the absolute, #, limits have been entered.)

For example, take a typical Switched Mode Power Supply transformer with windings in the ratio of **200:10**.

Typically, a prior measurement of inductance will have confirmed the correct number of primary turns have been fitted with the correct cores. Setting absolute limits of **0 on the primary and 1 on the secondary** will result in limits of.

$$\text{Nominal Ratio: } 200/10 \quad = 20$$

$$\text{Ratio + 1 sec turn} \quad = 18.18$$

$$\text{Ratio -1 sec turn} \quad = 22.22$$

$$\text{Limits calculated by tester} = (0/200 + 1/10) \times 100\% = +/- 10\%$$

The equivalent ratio limits used by tester are:

$$\text{Upper limit} = 22. \text{ Lower Limit} = 18$$

Which equates to the actual ratios with a one turn error on the secondary.

In general, the voltages obtained during any voltage turns ratio test will not equate exactly to the theoretical calculation of  $N_p / N_s$ , because, for example, of the relative positions of the windings with respect to each other and the core.

## General Rule

When setting turns ratio limits in absolute terms, use a limit of  $\frac{1}{2}$  turn less than the number of turns you want to detect. In this case set a limit of 0 (pri) and  $\frac{1}{2}$  (sec). This will result in equivalent limits of 19 and 21. Ideal for detecting an error of 1 turn or more.

## What happens if I set both absolute limits for both primary and secondary windings?

If you want to detect up to a 10-turn error on the primary and 1 turn on the secondary in the above example, set  $9\frac{1}{2}$  (pri) and  $\frac{1}{2}$  (sec). The tester uses the equivalent ratio limits: 21.95 and 18.05. Setting both limits WIDENS the limit to allow for an error of 10 Turn on the primary SIMULTANEOUSLY with 1 turn on the secondary.

i.e., to allow 190:11 (17.27) and 210:9 (23.33).

Notice that these limits will NOT detect just a 1 turn error on the secondary because you have now chosen limits to allow for errors on both primary and secondary, resulting in a broader tolerance on the absolute ratio.

## How do I set limits that will detect a 1 turn error in either the primary or secondary winding?

To do this you must set limits that will detect the smallest possible error. This will be due to the 1 turn error being on the winding with the largest number of turns.

In the above example, then, set absolute limits of  $\frac{1}{2}$  turn (pri) and 0 turn (sec)

(Remember to use the  $n-\frac{1}{2}$  rule).

The equivalent limits used by the tester will be:

20.05 and 19.95

This will certainly detect a 1 turn error in the primary, but because of the physical errors already described these limits may be too severe for a normal good part.

Therefore, a combination of inductance and turns ratio tests are normally used to confirm the correct assembly of transformers.

The polarity test may be selected as (+), (-) or no test. To measure the exact interwinding phase angle use the PHAS test.

### 2.5.13. TRL - Turns Ratio (by Inductance)

The TRL test measures the turns ratio between a pair of windings by comparing their inductance.

This is different from the TR test, which compares the voltage used to energize one winding, with the voltage induced on a second.

The TRL test is preferable to the TR test when the coupling between the primary and secondary windings is poor.

An alternating voltage is applied to each winding in turn. The alternating currents that flow and the applied voltage at the transformer are measured. From these measured currents and voltages, a complex impedance is derived, and the inductance is then calculated.

The turns ratio is computed by dividing the square root of the primary inductance by the square root of the secondary inductance.

On selecting 'TRL Turns Ratio (from inductance)' from the available tests window, a dialogue box will be displayed.

TRL Turns Ratio (from Inductance)

Integration  
 Short  Medium  Long

Test Parameters  
 Voltage(P)   mV  V  
 Voltage(S)   mV  V  Auto  
 Frequency   Hz  kHz  MHz

Primary Terminals  
 High Terminal  Low Terminal

Secondary Terminals  
 High Terminal  Low Terminal

Ratio Limits  
 % Primary : Secondary  :   
 # Negative Error  % Positive Error  %

Polarity  
 +ve  -ve  No Test

Compensation  
 Load Compensation

User Offset  
 User Offset Enabled

Save Measure Cancel

To program the test:

In the fields provided, insert the voltage and frequency you require for the test (see AT5600 User Manual Ch7 - 'Test Conditions').

Select the integration time you require. 'Medium' is the default setting. 'Long' will give more stable readings (for tighter limits) at the expense of an increased test time, and 'Short' will test at the maximum speed but may give a slightly noisier reading. See AT5600 manual 7.3 Explanation of Integration.

Select the high and low terminals of the primary winding. (Click on the arrow to the right of the fill-in box and you will be provided with a choice of the available terminals. Click the required terminal.)

Select the high and low terminals of the secondary winding.

Select Ratio (%), or Turns (#) limits.

Enter the required limits:

Ratio (%)                      Enter the nominal Primary to Secondary ratio, together with the limits as positive and negative percentage values.

Turns (#)                      In turns mode, you may set upper and lower limits on the primary and secondary windings. The transformer tester will then set limits on the turns ratio which are equal to the sum of these two errors, e.g.:

Primary                      100 turns                      ± 2 turns

secondary                      100 turns                      ± 2 turns

the tester will set the following limits on the ratio:

upper limit = 104/100                      lower limit = 96/100

If you wish to set limits on only one winding, you must enter zero (0) as the limit for the other winding.

If required, the polarity of the test can be checked. Click on the expected polarity of the transformer turns, otherwise disable the test by selecting 'No Test'.

Select OK. The test specification will be displayed in the program window on the screen.

## **AUTO secondary test conditions**

Optionally, The AT Editor will also allow you to specify the V/F on the primary, and AUTO conditions for the secondary.

With this selected, the AT will energize secondary for the L measurement at the same voltage as if the primary were energized.

In summary, the AT process for the AUTO setting is.

- 1, Measure the inductance and voltage on the primary.
- 2, Leaving the generator on, measure the secondary voltage
- 3, Connect the generator to the secondary at the voltage measured in step 2 and measure the inductance.

## 2.5.14. Z - Impedance

The Winding Impedance test measures the impedance of a selected winding using specified voltage (or current) and frequency conditions.

An AC voltage is applied across the winding under test and the complex impedance is determined from measurement of the test voltage and the flowing current. The Z result is the magnitude of this impedance.

This test is normally used for audio & telecommunication transformers to check the impedance presented to the transformers input and output.

On selecting "Z Winding Impedance" from the 'available tests' window, the following dialog box is displayed:

**Z Winding Impedance**

Integration  
 Short  Medium  Long

Test Parameters  
 Signal   mV  V  mA  
 Frequency   Hz  kHz  MHz

Terminals  
 High Terminal  Low Terminal

Impedance Limits  
 %  >=  <=  >  <  
 Minimum   mOhm  Ohm  kOhm  MOhm  
 Maximum   mOhm  Ohm  kOhm  MOhm

Compensation  
 Load Compensation  mOhm

User Offset  
 User Offset Enabled  mOhm

Save Measure Cancel



To program the test:

Enter the value of voltage (or current) for the signal and the required frequency of the test. (If in doubt, refer to AT5600 manual Ch 7 - 'Test Conditions', which lists recommended test conditions.)

Select the integration time required. 'Medium' is the default setting. 'Long' will give more stable readings (for tighter limits) at the expense of an increased test time, and 'Short' will test at the maximum speed, but may give a slightly noisier reading. See AT5600 manual 7.3 Explanation of Integration.

Enter the terminal names between which the impedance is to be measured.

Set the impedance limits.

% Enter a nominal value and then the limits as negative and positive values.

>< Enter minimum and maximum values.

> Enter just a minimum value.

< Enter just a maximum value.

Note: The Measure button may be used here as outlined in section 2.4.10

Select OK.

The test specification will then be displayed in the program window.

### 2.5.15. ZB - Impedance with Bias

The Winding Impedance test measures the impedance of a selected winding using specified voltage (or current) and frequency conditions. An AC voltage is applied across the winding under test and the complex impedance is determined from measurement of the test voltage and the flowing current.

The Z result is the magnitude of this impedance.

This test is normally used for audio & telecommunication transformers to check the impedance presented to the transformers input and output.

On selecting "Z Winding Impedance" from the 'available tests' window, the following dialog box is displayed:

**ZB Impedance with Bias**

Integration  
 Short  Medium  Long

Test Parameters  
 Signal   mV  V  mA  
 Frequency   Hz  kHz  MHz  
 Bias Current  mA  
 Note: AT3600 and AT1600 max bias is 400mA

Terminals  
 High Terminal  Low Terminal

Impedance Limits  
 %  >< Minimum   mOhm  Ohm  kOhm  MOhm  
 >  < Maximum   mOhm  Ohm  kOhm  MOhm

Compensation  
 Load Compensation  mOhm

User Offset  
 User Offset Enabled  mOhm

Save Measure Cancel

To program the test:

Enter the value of voltage (or current) for the signal and the required frequency of the test. (If in doubt, refer to AT5600 manual Ch 7 - 'Test Conditions', which lists recommended test conditions.)

For the impedance with bias test, you must also set a DC bias current to apply during the test.

Select the integration time required. 'Medium' is the default setting. 'Long' will give more stable readings (for tighter limits) at the expense of an increased test time, and 'Short' will test at the maximum speed but may give a slightly noisier reading. See AT5600 manual 7.3 Explanation of Integration.

Enter the terminal names between which the impedance is to be measured.

Set the impedance limits.

% Enter a nominal value and then the limits as + / - % values.

>< Enter minimum and maximum values.

> Enter just a minimum value.

< Enter just a maximum value.

Note: The Measure button may be used here as outlined in section 2.4.10.

Select OK.

The test specification will then be displayed in the program window.

## 2.5.16. R2 - Resistance Match

The resistance match test calculates the ratio between two resistances on two windings.

This test is suitable for switched mode power supply transformers, and audio & telecommunication transformers. It checks the matching between windings.

On selecting 'R2 a dialogue box will be displayed.

**R2 Winding Resistance Match**

Integration  
 Short  Medium  Long

Terminals (X)  
 High Terminal:  Low Terminal:

Terminals (Y)  
 High Terminal:  Low Terminal:

Matching Limits  
 X Resistance:   mOhm  Ohm  kOhm  MOhm  
 Y Resistance:   mOhm  Ohm  kOhm  MOhm  
 Negative Error:  % Positive Error:  %

Compensation  
 Load Compensation

User Offset  
 User Offset Enabled  Ratio [X/Y]

Save Measure Cancel

To program the test:

Select the integration time you require. 'Medium' is the default setting. 'Long' will give more stable readings (for tighter limits) at the expense of an increased test time, and 'Short' will test at the maximum speed but may give a slightly noisier reading. See AT5600 manual 7.3 Explanation of Integration.

Enter the terminal names between which the X resistance is to be measured.

Enter the terminal names between which the Y resistance is to be measured.

Set the resistance ratio limits by entering the X and Y nominal values and an allowed % error for the ratio result.

Note: The Measure button may be used here as outlined in section 2.4.10

## 2.5.17. L2 - Inductance Match

The inductance match test calculates the ratio between two inductances on two windings. An equivalent series inductance measurement is performed on each winding by measuring the complex impedance.

This test is suitable for switched mode power supply transformers, and audio & telecommunication transformers. It checks the matching between windings.

On selecting 'L2 Inductance Match a dialogue box will be displayed.

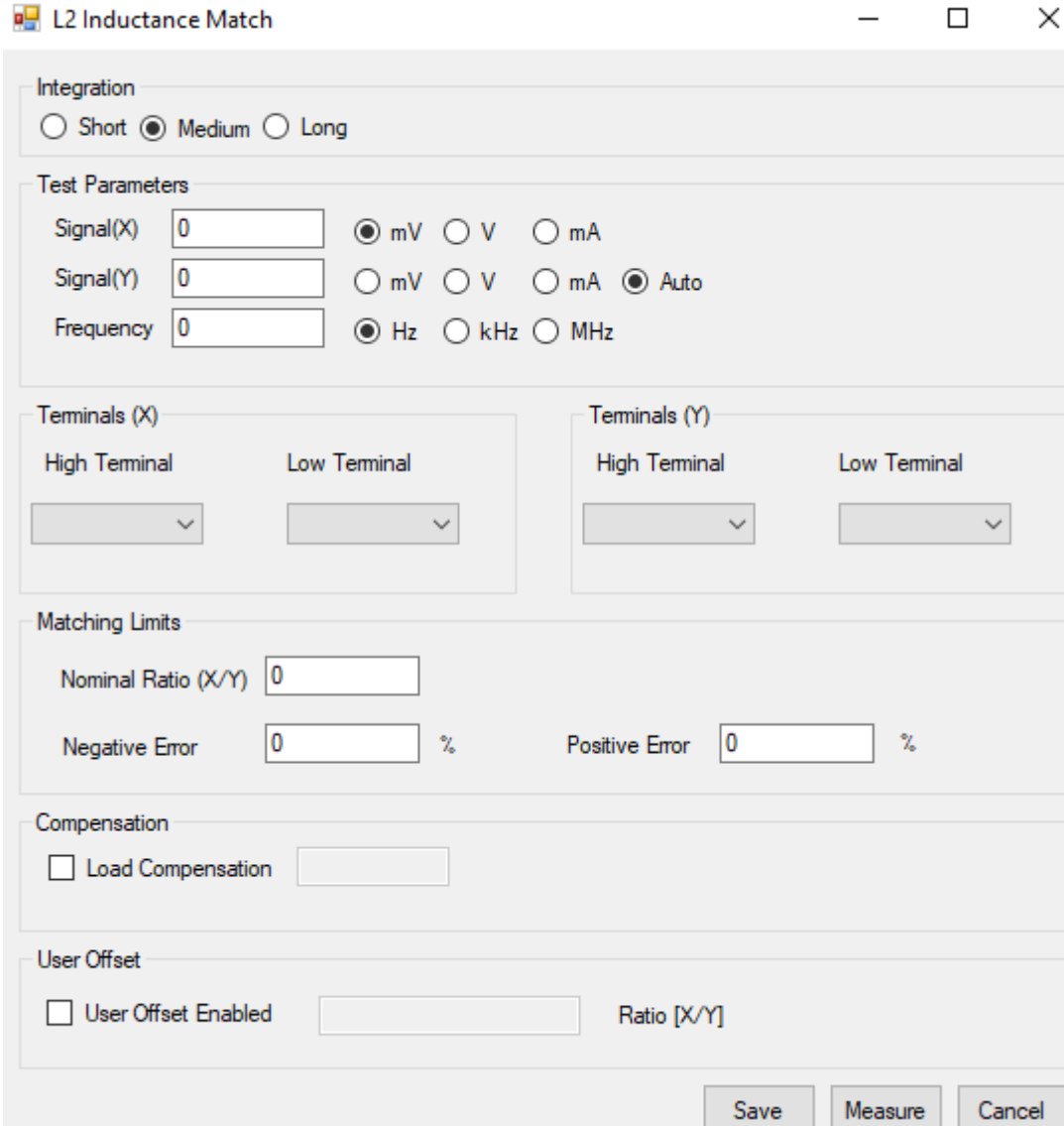
 L2 Inductance Match

Integration  
 Short  Medium  Long

Test Parameters  
 Signal(X)   mV  V  mA  
 Signal(Y)   mV  V  mA  Auto  
 Frequency   Hz  kHz  MHz

Terminals (X)  
 High Terminal  Low Terminal

Terminals (Y)  
 High Terminal  Low Terminal

Matching Limits  
 Nominal Ratio (X/Y)   
 Negative Error  % Positive Error  %

Compensation  
 Load Compensation

User Offset  
 User Offset Enabled  Ratio [X/Y]

Save Measure Cancel

To program the test:

Enter the required values of frequency and current or voltage for the X and Y windings (If in doubt, refer to AT5600 manual Ch 7 - 'Test Conditions', which lists recommended test conditions.)

Select the integration time you require. 'Medium' is the default setting. 'Long' will give more stable readings (for tighter limits) at the expense of an increased test time, and 'Short' will test at the maximum speed but may give a slightly noisier reading. See AT5600 manual 7.3 Explanation of Integration.

Enter the terminal names between which the X inductance is to be measured.

Enter the terminal names between which the Y inductance is to be measured.

Set the inductance ratio limits by specifying a nominal ratio and the allowed % deviation .

Note: The Measure button may be used here as outlined in section 2.4.10.

Select OK. The test specification will then be displayed in the program window.

## 2.5.18. C2 - Capacitance Match

The Interwinding capacitance match test calculates the ratio between two capacitance measurements on two groups of windings. It is measured by applying a specified AC voltage between two separate windings and the voltage across and current flow between the two windings is measured to obtain a complex impedance. This is performed to the two groups in turn.

This test is suitable for switched mode power supply, audio, and telecommunication transformers. It checks that the windings are installed in the correct positions on the bobbin.

On selecting "C2 Interwinding Capacitance Match" from the available tests window, a dialogue box will be displayed.

**C2 Capacitance Match**

Integration  
 Short  Medium  Long

Test Parameters  
 Voltage   mV  V  
 Frequency   Hz  kHz  MHz

High Terminals[X]  
 Available: 1, 2, 4, 5, 7, 9  
 Used:   
 Add -> <- Remove

Low Terminals[X]  
 Available: 1, 2, 4, 5, 7, 9  
 Used:   
 Add -> <- Remove

High Terminals[Y]  
 Available: 1, 2, 4, 5, 7, 9  
 Used:   
 Add -> <- Remove

Low Terminals[Y]  
 Available: 1, 2, 4, 5, 7, 9  
 Used:   
 Add -> <- Remove

Matching Limits  
 Nominal Ratio (X/Y)   
 Negative Error  % Positive Error  %

Compensation  
 Load Compensation

User Offset  
 User Offset Enabled  Ratio [X/Y]



To program the test:

Enter the voltage and frequency required for the test. (Refer to AT5600 manual Ch 7 - 'Test Conditions', which lists recommended test conditions for different values of capacitance.)

Select the integration time you require. 'Medium' is the default setting. 'Long' will give more stable readings (for tighter limits) at the expense of an increased test time, and 'Short' will test at the maximum speed, but may give a slightly noisier reading. See AT5600 manual 7.3 Explanation of Integration.

Select the X high and low terminals

Select the Y high and low terminals

Set the nominal capacitance ratio and allowed % deviation limits.

Note: The Measure button may be used here as outlined in section 2.4.10.

Select OK. The test specification will then be displayed in the program window.

### 2.5.19. GBAL - General Longitudinal Balance

The general longitudinal balance test is intended to measure what is effectively the Common Mode Rejection Ratio of a transformer designed to connect to a balanced line.

Two measurements are performed each by applying a voltage to the transformer and measuring the resulting voltage to calculate the CMRR.

To overcome the differences of three standard methods of measuring the CMRR the GBAL dialogue box has a separate group of terminals X and Y for the first and second measurements, respectively. The preferred method of measurement is the LBAL test for which Voltech provide a separate test specifically for this measurement.

This test is suitable for audio & telecommunication transformers and checks the effective common mode rejection ratio of the transformer.

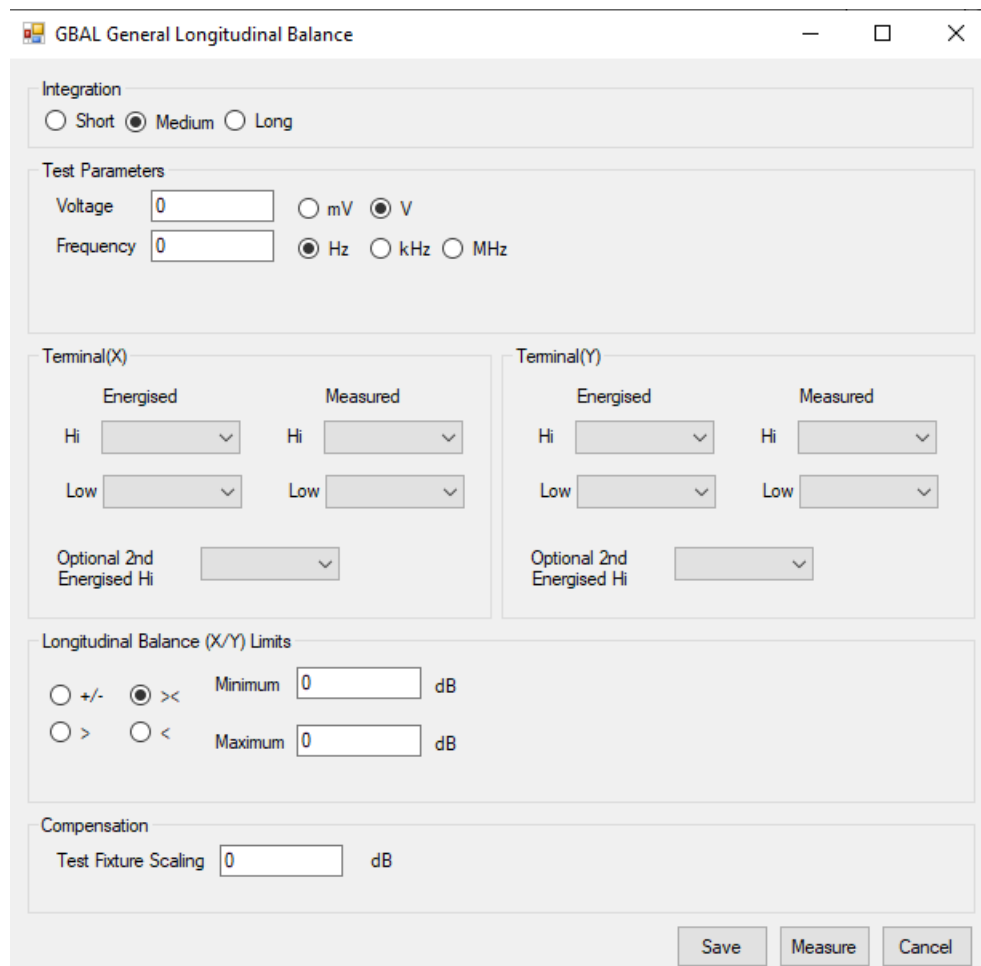

On selecting "GBAL General Longitudinal Balance" from the available tests window, a dialogue box will be displayed:

To program the test:

Enter the voltage and frequency parameters of the test signal. (If in doubt, refer to AT5600 manual Ch 7 - 'Test Conditions', which lists recommended test conditions).

Select the integration time you require 'Medium' is the default setting. 'Long' will give more stable readings (for tighter limits) at the expense of an increased test time, and 'Short' will test at the maximum speed, but may give a slightly noisier reading. See AT5600 manual 7.3 Explanation of Integration.

Enter the names for the energized and measured terminals for the X measurement.

Then, similarly configure Y terminals.

When required the "Optional 2nd Energized Hi" allows an additional terminal connection to the energized high node.

Set (X/Y) limits.

+/- Enter a nominal value and then the limits as negative and positive values.

>< Enter minimum and maximum values.

> Enter just a minimum value.

< Enter just a maximum value.

Since components on the test fixture may scale measured readings the "Compensate for Test Fixture Scaling" allows the test to account for this

Note: The Measure button may be used here as outlined in section 2.4.10.

Select OK. The test specification will then be displayed in the program window.

### 2.5.20. LBAL - Longitudinal Balance

The longitudinal balance test is Voltech's preferred method to measure what is effectively the Common Mode Rejection Ratio of a transformer designed to connect to a balanced line. Two measurements are performed each by applying a voltage to the transformer and measuring the resulting voltage to calculate the CMRR.

This test is suitable for audio & telecommunication transformers and checks the effective common mode rejection ratio of the transformer.

On selecting "LBAL Longitudinal Balance" from the available tests window, a dialogue box will be displayed:

**LBAL Longitudinal Balance**

Integration  
 Short  Medium  Long

Test Parameters  
 Voltage   mV  V  
 Frequency   Hz  kHz  MHz

Input  
 High Terminal  Low Terminal   
 Common Terminal

Output  
 High Terminal  Low Terminal

Longitudinal Balance Limits  
 +/-  >< Minimum  dB  
 >  < Maximum  dB

Compensation  
 Load Compensation  dB

User Offset  
 User Offset Enabled  dB

Save Measure Cancel

To program the test:

Enter the voltage and frequency parameters of the test signal.

Select the integration time you require. 'Medium' is the default setting. 'Long' will give more stable readings (for tighter limits) at the expense of an increased test time, and 'Short' will test at the maximum speed, but may give a slightly noisier reading. See AT5600 manual 7.3 Explanation of Integration.

Enter the names of the Hi and Lo input terminals and Common Terminal.

Enter the names of the Hi and Lo output terminals.

Set the longitudinal balance limits.

- +/- Enter a nominal value and then the limits as negative and positive values.
- >< Enter minimum and maximum values.
- > Enter just a minimum value.
- < Enter just a maximum value

Note: The Measure button may be used here as outlined in section 2.4.10.

Select OK. The test specification will then be displayed in the program window

### 2.5.21. ILOS - Insertion Loss

The Insertion loss test measures the output power delivered by a transformer to a load, relative to the maximum power theoretically available.

A voltage is applied to the input winding and the input/output voltages are measured to calculate the loss.

This test is suitable for audio & telecommunication transformers and checks the effective losses in the transformer when used for its application.

On selecting "ILOS Insertion Loss" from the available tests window, a dialogue box will be displayed.

**ILOS Insertion Loss**

Integration  
 Short  Medium  Long

Test Parameters  
 Voltage   mV  V  
 Frequency   Hz  kHz  MHz

Input  
 High Terminal  Low Terminal   
   
 Source resistance  Ohm

Output  
 High Terminal  Low Terminal   
   
 Load resistance  Ohm

Insertion Loss Limits  
 +/-  >< Minimum  dB  
 >  < Maximum  dB

Compensation  
 Load Compensation  dB

User Offset  
 User Offset Enabled  dB

**Save** **Measure** **Cancel**

To program the test:

Enter the voltage and frequency parameters of the test signal. (Refer to AT5600 manual Ch 7 - 'Test Conditions', which lists recommended test conditions).

Select the integration time you require. 'Medium' is the default setting. 'Long' will give more stable readings (for tighter limits) at the expense of an increased test time, and 'Short' will test at the maximum speed but may give a slightly noisier reading. See AT5600 manual 7.3 Explanation of Integration.

Enter the names of the Hi and Lo input terminals and value of source resistance.

Enter the names of the Hi and Lo output terminals and value of load resistance.

Set the insertion loss limits.

+/- Enter a nominal value and then the limits as negative and positive values.

>< Enter minimum and maximum values.

> Enter just a minimum value.

< Enter just a minimum value

Note: The Measure button may be used here as outlined in section 2.4.10.

Select OK. The test specification will then be displayed in the program window.

## 2.5.22. RESP - Frequency Response

The frequency response test, RESP, may be used to check that the variation in power loss of a telecommunications or audio transformer over a specified frequency range is less than specified limits.

The RESP test consists of several Insertion Loss (ILOS) tests repeated at different frequencies.

The dialog box 'RESP Frequency Response' contains the following sections and controls:

- Integration:** Radio buttons for Short, Medium (selected), and Long.
- Test Parameters:**
  - Voltage: Input field with '0', radio buttons for mV and V (selected).
  - Reference Frequency: Input field with '0', radio buttons for Hz (selected), kHz, and MHz.
- Test Frequencies:**
  - New Frequency: Input field.
  - Frequency List: List box.
  - Radio buttons for Hz (selected), kHz, and MHz.
  - Buttons: Add -> and Delete.
- Input:**
  - High Terminal: Dropdown menu.
  - Low Terminal: Dropdown menu.
- Output:**
  - High Terminal: Dropdown menu.
  - Low Terminal: Dropdown menu.
- Frequency Response Limit:**
  - Lower Limit: Input field with '0', followed by 'dB'.
  - Upper Limit: Input field with '0', followed by 'dB'.
- Compensation:**
  - Load Compensation: Checkbox, input field, followed by 'dB'.
- User Offset:**
  - User Offset Enabled: Checkbox, input field, followed by 'dB'.
- Buttons:** Save and Cancel.



To program the test:

Enter the voltage and frequency parameters of the reference test signal. (Refer to AT5600 manual Ch 7 - 'Test Conditions', which lists recommended test conditions).

Select the integration time required. 'Medium' is the default setting. 'Long' will give more stable readings (for tighter limits) at the expense of an increased test time, and 'Short' will test at the maximum speed but may give a slightly noisier reading. See AT5600 manual 7.3 Explanation of Integration.

Enter the names of the Hi and Lo input terminals.

Enter the names of the Hi and Lo output terminals.

Add test frequencies as required by entering the frequency and clicking 'add'.

Set the frequency response limits.

Select OK. The test specification will then be displayed in the program window.

### 2.5.23. RLOS - Return Loss

The Return loss test measures the impedance mismatch between the transformer and a transmission line of a specified impedance.

RLOS is calculated from a measurement of the complex impedance and the specified impedance.

This test is suitable for audio & telecommunication transformers and checks the effective input impedance of the transformer in the application.

On selecting "RLOS Return Loss" from the available tests window, the following dialogue box is displayed:

**Integration**  
 Short  Medium  Long

**Test Parameters**  
 Voltage   mV  V  
 Frequency   Hz  kHz  MHz

**Terminals**  
 High Terminal  Low Terminal

**Reference Impedance**  
 Real  Ohm  
 Imaginary  Ohm

**Return Loss Limits**  
 +/-  >< Minimum  dB  
 >  < Maximum  dB

**Compensation**  
 Load Compensation  dB

**User Offset**  
 User Offset Enabled  dB

Save Measure Cancel

To program the test:

Enter the voltage and frequency parameters of the test signal. (If in doubt, refer to AT5600 manual Ch 7 - 'Test Conditions', which lists recommended test conditions).

Select the integration time you require. 'Medium' is the default setting. 'Long' will give more stable readings (for tighter limits) at the expense of an increased test time, and 'Short' will test at the maximum speed but may give a slightly noisier reading. See AT5600 manual 7.3 Explanation of Integration.

Enter the names of the Hi and Lo input terminals and value of the reference impedance (real and imaginary , in ohms).

Set the return loss limits.

+/- Enter a nominal value and then the limits as negative and positive values.

>< Enter minimum and maximum values.

> Enter just a minimum value.

< Enter just a maximum value.

Note: The Measure button may be used here as outlined in section 2.4.10.

Select OK. The test specification will then be displayed in the program window.

## 2.5.24. ANGL - Impedance Phase Angle

The Impedance Phase Angle test can measure the impedance of a selected winding using specified voltage (or current) and frequency conditions, and then reports the equivalent impedance phase.

An AC voltage is applied across the winding under test and the complex impedance is determined from measurements of the voltage across the winding and the current flowing through it.

The ANGL result is the phase of this complex impedance, it is the phase angle between the voltage and current.

This test is normally used for audio & telecommunication transformers along with the Z (impedance) test to check the complex impedance presented to the transformers input and output.

On selecting “ANGL Impedance Phase Angle” from the ‘available tests’ window, the following dialogue box will be displayed:

ANGL Impedance Phase Angle

Integration  
 Short  Medium  Long

Test Parameters  
 Signal   mV  V  mA  
 Frequency   Hz  kHz  MHz

Terminals  
 High Terminal  Low Terminal

Phase Limits  
 +/-  >< Minimum  Degs  
 Maximum  Degs

Compensation  
 Load Compensation  Degs

User Offset  
 User Offset Enabled  mOhm

Save Measure Cancel

To program the test:

Enter the value of voltage (or current) for the signal and the required frequency of the test. (If in doubt, refer to AT5600 manual Ch 7 - 'Test Conditions', which lists recommended test conditions.)

Select the integration time required. 'Medium' is the default setting. 'Long' will give more stable readings (for tighter limits) at the expense of an increased test time, and 'Short' will test at the maximum speed, but may give a slightly noisier reading. See AT5600 manual 7.3 Explanation of Integration.

Enter the terminal names between which the impedance is to be measured.

Enter the phase limits.

For phase tests, the convention of the result returned by the AT depends on the minimum limit requested.

If this limit is  $>0$  the result returned is between  $0^{\circ}$  and  $360^{\circ}$ . If the minimum limit is  $>-180$  deg and  $0$  deg, the result returned is between  $-180^{\circ}$  and  $180^{\circ}$ , otherwise the result returned is between  $-360^{\circ}$  and  $0^{\circ}$ .

This is done to ensure continuity of results and ease of setting limits irrespective of where the phasor diagram is being checked.

Note: The Measure button may be used here as outlined in section 2.4.10.

Select 'OK'. The test specification will then be displayed in the program window.

## 2.5.25. PHAS - Interwinding Phase Test

The interwinding phase may be tested between one winding and another.

A test source voltage is applied to one winding, and the voltages across two other windings (one of which may be the driven winding) are measured.

The interwinding phase is measured by finding the phase difference between the signal waveforms measured on your chosen primary and secondary windings.

This test is suitable for most types of transformers although unusual with line frequency transformers, it tests the windings for the correct phasing. It is most useful for determining the effect of audio and telecommunications transformers when placed in a transmission line.

On selecting "PHAS Interwinding Phase" from the 'available tests' window, the following dialog box is displayed:

PHAS Interwinding Phase

Integration  
 Short  Medium  Long

Test Parameters  
 Voltage   mV  V  
 Frequency   Hz  kHz  MHz

Energised Terminals  
 High Terminal  Low Terminal

Primary Terminals  
 High Terminal  Low Terminal

Secondary Terminals  
 High Terminal  Low Terminal

Phase Limits  
 +/-  >< Minimum  Degs  
 Maximum  Degs

Compensation  
 Load Compensation  Degs

User Offset  
 User Offset Enabled  Degs

Save Measure Cancel

To program the test:

Enter the value of voltage for the signal and the required frequency of the test. (If in doubt, refer to AT5600 manual Ch 7 - 'Test Conditions', which lists recommended test conditions.)

Select the integration time required. 'Medium' is the default setting. 'Long' will give more stable readings (for tighter limits) at the expense of an increased test time, and 'Short' will test at the maximum speed, but may give a slightly noisier reading. See AT5600 manual 7.3 Explanation of Integration.

Enter the terminal names of the winding to be energized.

Enter the terminal names of the primary and secondary windings on which the PHAS test is to be performed. Note: either of these windings can be the energized winding.

Set the phase limits:

For phase tests, the convention of the result returned by the AT depends on the mean of the limits you have requested.

The Mean of the Min and max limits are calculated, and the results will be expressed within the range (Mean – 180 deg) and (Mean +180deg)

For example,

A, if the Limits are -5 Deg to + 5 Deg then the mean is 0Deg and the result will be in the range -180 deg to 180 deg.

B, if the Limits are 85 Deg to 95 Deg then the mean is 90 Deg and the result will be in the range -90 deg to +270 deg.

B, if the Limits are 40 Deg to 60 Deg then the mean is 50 Deg and the result will be in the range -130 deg to +230 deg.

Note: The Measure button may be used here as outlined in section 2.4.10.

Select 'OK'. The test specification will then be displayed in the program window.

## 2.5.26. OUT - Output to User Port

The User Port on the AT5600 has 6 'Relay Driver' outputs associated with it.

The OUT test allows programming of the User Port relay driver outputs to perform additional relay switching as part of the test program.

An example of this would be an application where a transformer has two separate primary windings. An OUT test could be used to connect them in series, allowing them to be tested as a single primary with twice the working voltage.

A second example is the switching of additional resistors mounted on the test fixture allowing tests to be included in a program on a transformer with a loaded secondary winding.

Each of the relay driver outputs can be set to on or off (closed or open respectively) as shown:

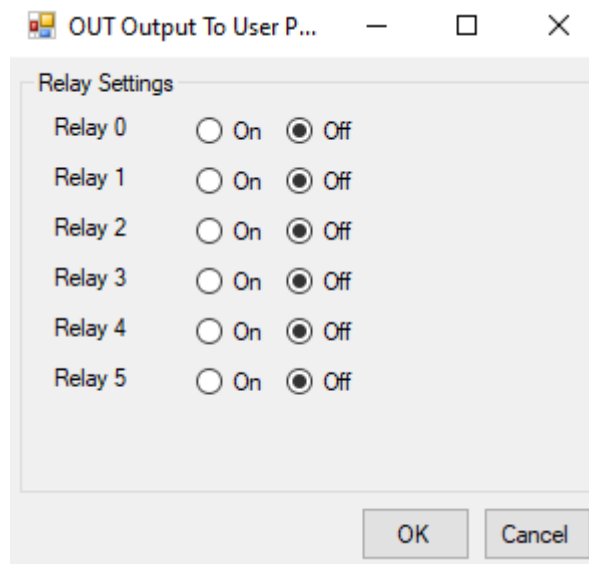

Once the settings are correct click on OK to accept them.

Note: The relay drivers are only set as and when the tester encounters an OUT test. The settings given will remain in place until another OUT test is encountered. Therefore, if the settings are required for one part of the test program only, two OUT tests will be required, the first to turn the appropriate relay drivers on and the second to turn them back off.

See the AT5600 user manual Specification for details of the relay driver configuration.



### 2.5.27. HPDC - DC Hi-Pot (EHT)

The DC high-pot (or EHT) test is used to check for safety isolation between windings, or between windings and the core or screens.

During the test, a DC voltage is applied across two groups of windings with the windings in each group being shorted together.

The voltage and current are monitored throughout the dwell time; if either the test voltage cannot be maintained, or the current is too large, then a failure will be recorded.

On selecting 'HPDC High-Pot DC' from the Available Tests window, a dialogue box will be displayed:

The dialog box 'HPDC Hi-Pot DC' contains the following configuration options:

- Test Parameters:**
  - Voltage: 0 (unit: V selected)
  - Ramp-Up Time: 0 sec
  - Dwell Time: 0 sec
- High Terminals:**
  - Available: 1, 2, 4, 5, 7, 9
  - Used: (empty)
  - Buttons: Add ->, <- Remove
- Low Terminals:**
  - Available: 1, 2, 4, 5, 7, 9
  - Used: (empty)
  - Buttons: Add ->, <- Remove
- Test Limit:**
  - Maximum Current: 0 (unit: mA selected)
- Compensation:**
  - Load Compensation: (checkbox unchecked)
- User Offset:**
  - User Offset Enabled: (checkbox unchecked)

Buttons at the bottom: Save, Measure, Cancel.

To program the test:

Enter the test voltage, and the ramp-up and dwell times.

Enter the terminal names for the High and Low Terminals.

Click with the mouse to select a terminal from the Available list; then click the 'Add >' button to transfer it to the Used list. (To correct a mistake, click with the mouse to select a terminal from the Used list; then click the '< Remove' button to transfer it back to the Available list).

**See AT5600 manual 7.28 for best practice advice on selection of nodes.**

Enter the maximum current value in the bottom section.

Select OK. The test specification will then be displayed in the program window.

### 2.5.28. HPAC - AC Hi-Pot (EHT)

The AC high-pot (or EHT) test is used to check for safety isolation between windings, or between windings and the core or screens.

During the test, an AC voltage is applied across two groups of windings with the windings in each group being shorted together.

The voltage and current are monitored throughout the dwell time; if either the test voltage cannot be maintained, or the current is too large, then a failure will be recorded.

On selecting 'HPAC High-Pot AC' from the Available Tests window, a dialogue box will be displayed:

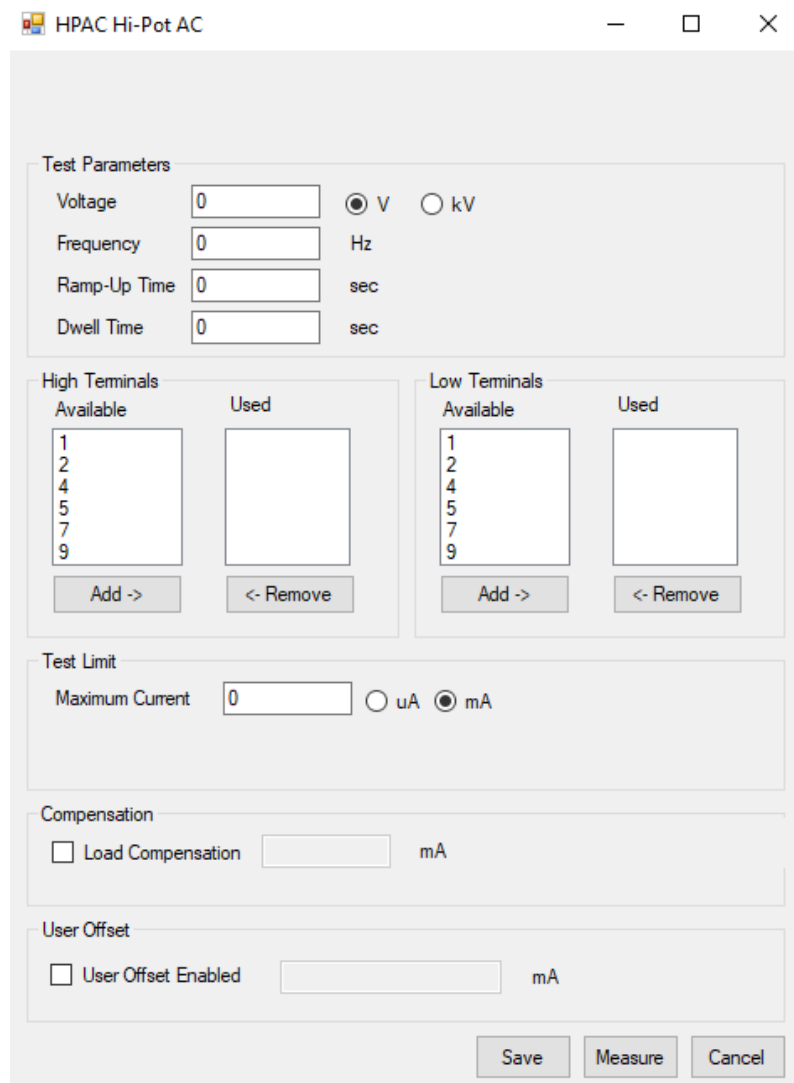

To program the test:

Enter the test voltage, the test frequency, and the ramp-up and dwell times.

Enter the terminal names for the High and Low Terminals.

Click with the mouse to select a terminal from the Available list; then click the 'Add >' button to transfer it to the Used list. (To correct a mistake, click with the mouse to select a terminal from the Used list; then click the '< Remove' button to transfer it back to the Available list).

**See AT5600 manual 7.29 for best practice advice on selection of nodes.**

Enter the maximum current value in the bottom section. Note that the current is the peak value, not an RMS.

Select OK. The test specification will then be displayed in the program window.

## 2.5.29. LVOC - Low Voltage Open Circuit

Applying an AC voltage to the primary of the transformer will produce an AC voltage in the secondary.

Low Voltage Open Circuit measures the 'open circuit' voltage produced when the specified test signal is applied.

The secondary voltage may be in phase with the primary voltage, or it may be anti-phase depending on the winding and the termination of the windings.

LVOC Low Voltage Open Circuit
— □ ×

**Integration**

Short  Medium  Long

**Test Parameters**

Voltage  V

Frequency  Hz

**Energised Terminals**

High Terminal  Low Terminal

**Measured Terminals**

High Terminal  Low Terminal

**Voltage Limits**

%  >> Minimum   mV  V

>  < Maximum   mV  V

Note: ATi maximum limit is 5V(ac), 8V(dc)

**Polarity**

+ve  -ve  No Test

**Measurement**

AC Voltage

DC voltage

**Compensation**

Load Compensation  mV

**User Offset**

User Offset Enabled  mV

To program the test:

Choose the integration period (normally 'medium').

Enter the required test signal.

Enter the terminals to be used.

Energized terminals: The terminals where the test signal will be applied. This is normally the winding with the greatest number of turns.

Measured terminals 'High' and 'Low':

Choosing the test limits.

The voltage test limits can be:

- % A nominal value together with + and - % limits.
- >< Minimum and maximum values
- > A minimum value only
- < A maximum value only

An optional polarity test can be selected if required.

The Measure button may be used here as outlined in section 2.4.10.

### **2.5.30. ACRT - AC Hi-Pot Ramp**

This test has been withdrawn and is no longer supported.

### **2.5.31. DCRT - DC Hi-Pot Ramp**

This test has been withdrawn and is no longer supported.



### **2.5.32. ACVB - AC Voltage Break Down**

This test has been withdrawn and is no longer supported

### **2.5.33. DCVB - DC Voltage Break Down**

This test has been withdrawn and is no longer supported.

### 2.5.34. IR - Insulation Resistance

The insulation resistance may be measured between any number of windings.

A DC voltage is applied across two groups of windings, with the windings in each group being shorted together.

The voltage and current are measured; dividing the voltage by the current gives the insulation resistance.

On selecting 'IR - Insulation Resistance' from the available tests window, a form fill-in dialogue box will be displayed:

IR Insulation Resistance

Integration  
 Short  Medium  Long

Test Parameters  
 Voltage   V  kV

Note:ATi and AT1600 max is 500V

High Terminals		Low Terminals	
Available	Used	Available	Used
1		1	
2		2	
4		4	
5		5	
7		7	
9		9	

Insulation Resistance Limit  
 Minimum Resistance   MOhm  GOhm  
 Note:ATi and AT1600 maximum resistance limits is 10 GOhm

Compensation  
 Load Compensation  MOhms

User Offset  
 User Offset Enabled  MOhm

To program the test:

Enter the DC test voltage.

Select the integration time you require. 'Medium' is the default setting. 'Long' will give more stable readings (for tighter limits) at the expense of an increased test time, and 'Short' will test at the maximum speed but may give a slightly noisier reading. See AT5600 manual 7.3 Explanation of Integration.

Enter the terminal names for the High and Low Terminals.

**See AT5600 user manual 7.27 for best practice advice on selection of nodes.**

Enter the minimum insulation resistance value in the bottom section.

Note: The combination of test voltage and minimum resistance must be equivalent to a test current less than 1 mA.

The Measure button may be used here as outlined in section 2.4.10.

Select OK. The test specification will then be displayed in the program window.

### 2.5.35. SURG - Surge Stress Test

**WARNING:** Under no circumstances should the surge be applied to the input winding of a step-up transformer because it may produce voltages greater than the 7KV limit of the AT5600. The purpose of this test is to detect an inter-turn short by applying several high voltage impulses (or surges) to the selected winding.

Each impulse produces a sinusoidal transient which eventually decays to zero.

During the test, the tester measures the area (in Volt - seconds) under each transient. The decay is much shorter in a faulty winding and is detected as a smaller value for the measured area.

On selecting ‘SURG Stress Test - Surge’ from the Available Tests window, the following form-fill dialogue box will be displayed:

The dialog box 'SURG Surge Stress' contains the following controls:

- Test Parameters:**
  - Target Voltage:   V  kV
  - Number Of Impulses:
  - Winding Inductance:   uH  mH  H  kH  Auto
- Terminals:**
  - High Terminal:
  - Low Terminal:
- V-sec Area Limits:**
  - %  >< Minimum:   mVsec  Vsec
  - > Maximum:   mVsec  Vsec
- Compensation:**
  - Load Compensation  mVsec
- User Offset:**
  - User Offset Enabled  mVsec

Buttons: Save, Measure, Cancel

To program the test:

Enter the desired DC impulse test voltage.

Enter the number of impulses.

You may choose only to have one impulse; the test will be quicker to execute, but there will be less chance of promoting a failure in a transformer where the inter-turn insulation is damaged and weakened, but not yet causing a complete short. More impulses give a greater chance of detecting damaged insulation.

Enter either a nominal winding inductance or select AUTO mode.

When a fixed inductance is entered, the AT5600 uses this value to estimate the frequency and duration of the transient waveform and thus determine the digital waveform sampling rate that is used.

In AUTO mode, the tester automatically determines the ideal sample rate and duration after testing the first sample in a batch. AUTO mode is recommended for new test programs. If you are converting an existing test program from fixed to AUTO surge testing mode, beware that under some conditions the measured result may change. Note that the Inductance value may also be entered from a measurement on the specimen by using the Measure button.

Enter the high and low terminal names

Select the type of limits you require and enter the values.

%     Enter a nominal value and +/- % limits

><    Enter minimum and maximum values.

>     Enter just a minimum value.

It is very difficult to predict the minimum and maximum areas from theory. A practical approach is to use the Measure Button Remember that these limits are taken from only one transformer and may need to be revised after more have been tested.

If required, enter the load compensation value as outlined in section 13.5.

Select OK. The test specification will then be displayed in the program window.

### 2.5.36. ILK - Leakage Current Test

A leakage current test is needed for transformers used in certain applications, mainly medical, where it is an additional safety requirement.

The leakage current to be measured is that which flows between primary windings and secondary windings under normal operating conditions due to interwinding capacitance.

In a switching power supply, the primary circuits could be connected directly to the power line supply, and could experience the normal line voltage as a common signal with respect to ground. This AC signal could cause a significant leakage current to flow through the transformer to grounded secondaries.

This test is typically carried out by applying the test voltage between all the primary terminals shorted together and all the secondary terminals and screen shorted together.

On selecting "ILK Leakage Current" from the 'available tests' window, the following dialog box is displayed:

ILK Leakage Current

Integration  
 Short  Medium  Long

Test Parameters  
 Voltage  V  
 Frequency  Hz

High Terminals  
 Available:   
  
  
  
  
  
 Add ->    <- Remove

Low Terminals  
 Available:   
  
  
  
  
  
 Add ->    <- Remove

Test Limit  
 Maximum Current   uA  mA

Compensation  
 Load Compensation  mA

User Offset  
 User Offset Enabled  uA

Save    Measure    Cancel

To program the test:

Enter the value of DC voltage for the signal and the required frequency of the test.

Select the integration time required. 'Medium' is the default setting. 'Long' will give more stable readings (for tighter limits) at the expense of an increased test time, and 'Short' will test at the maximum speed, but may give a slightly noisier reading. See AT5600 manual 7.3 Explanation of Integration.

Select the terminals to be included for both high and low terminals. For both high and low terminals, select each terminal in turn and click on the 'Add' button at the bottom of the list. Terminals can be removed from the used list by selecting them and clicking on the 'Remove' button.

Select the current limit. There is only a maximum limit for this test.

The Measure button may be used here as outlined in section 2.4.10, however in most cases the current limit will be determined by the safety standard to which you are working.

Select 'OK'. The test specification will then be displayed in the program window.



### 2.5.37. MAGI - Magnetizing Current

Magnetizing current is measured by applying an AC test voltage to the selected winding and measuring the resulting current.

You may program the test to use either an RMS, or a mean-sense (RMS scaled) type of measurement to obtain a value for the current. Normally, an RMS measurement is preferred, but the mean-sense measurement is also available as it is used by some low-cost multi-meters.

On selecting 'MAGI Magnetizing Current' from the available tests window, a form fill-in dialogue box will be displayed:

MAGI Magnetising Current

Integration  
 Short  Medium  Long

Test Parameters  
 Voltage  V  
 Frequency  Hz

Terminals  
 High Terminal   Low Terminal

Measurement  
 RMS  
 Mean sense RMS Scaled

Magnetising Current Limits  
 >>  < Minimum   uA  mA  A  
 Maximum   uA  mA  A

Compensation  
 Load Compensation  mA

User Offset  
 User Offset Enabled  mA

Save Measure Cancel

To program the test:

Enter the voltage and frequency limits (refer to AT5600 User Manual Ch7 - 'Test Conditions' which lists recommended test conditions if required).

Select the type of measurement you require - RMS or Mean sense. If in doubt, see chapter 7 for more information.

Select the integration time you require. 'Medium' is the default setting. 'Long' will give more stable readings (for tighter limits) at the expense of an increased test time, and 'Short' will test at the maximum speed but may give a slightly noisier reading. See AT5600 manual 7.3 Explanation of Integration.

Enter the terminal names for the High and Low Terminals.

Select the type of limits you require and enter the values.

>< Enter minimum and maximum values.

< Enter just a maximum value.

Note: The Measure button may be used here as outlined in section 2.4.10.

Select OK. The test specification will then be displayed in the program window.

### 2.5.38. VOC - Open Circuit Voltage

Open circuit voltage is measured by applying an AC test voltage to a selected winding (usually a primary winding), and measuring the resulting voltage produced on another winding. You may program the test to use either the normal AC measurement, or a DC measurement, which could be used, for example, when testing transformers fitted with a rectifying diode.

If there are several windings to be tested, the program will execute more quickly if the following points are observed:

A Place all the open circuit voltage (VOC) tests consecutively at the same point in the program.

B, if possible, use the same energized winding, with the same test voltage and frequency for each test.

C If there is a magnetizing current (MAGI) test which has the same energized winding and the same test voltage and frequency, place this immediately before the first open circuit voltage test.

On selecting 'VOC Open Circuit Voltage' from the available tests window, the following form-fill dialogue box will be displayed:

To program the test:

Enter the test voltage and test frequency.

Select either AC Voltage, DC Voltage or Mean sense, RMS scaled measurement by clicking on the relevant button.

Select the integration time you require. 'Medium' is the default setting. 'Long' will give more stable readings (for tighter limits) at the expense of an increased test time, and 'Short' will test at the maximum speed but may give a slightly noisier reading. See AT5600 manual 7.3 Explanation of Integration.

Enter the terminal names for the Energized High and Low Terminals.

Similarly, enter the names for the Measured Terminals.

Select the type of limits you require and enter the values.

% Enter a nominal value and then the limits +/- %

>< Enter minimum and maximum values.

> Enter just a minimum value.

< Enter just a maximum value.

Click on the appropriate button to choose the polarity, or choose the 'No Test' button. (For AC measurements, use the positive polarity when the measured winding has the same phase as the energized winding, use the negative polarity when they have opposite phases.)

Note: The Measure button may be used here as outlined in section 2.4.10.

## 2.5.39. WATT - Wattage

The Wattage test is a measure of the input power required to energize a transformer at no load.

During the test, a constant, user specified AC voltage is applied across the winding in question; the power is then measured. All other windings are held open circuit during this test.

On selecting the WATT test the following dialogue box will be displayed:

**WATT Wattage** [ - ] [ □ ] [ × ]

**Integration**  
 Short  Medium  Long

**Test Parameters**  
 Signal   A  V  
 Nominal V  V  
 Frequency  Hz

**Terminals**  
 High Terminal  Low Terminal

**Wattage Limits**  
 >>  < Minimum   mW  W  
 Maximum   mW  W

**Compensation**  
 Load Compensation  mW

**User Offset**  
 User Offset Enabled  mW

[ Save ] [ Measure ] [ Cancel ]

To program the test:

Enter the test voltage and frequency.

Select the integration time you require. 'Medium' is the default setting. 'Long' will give more stable readings (for tighter limits) at the expense of an increased test time, and 'Short' will test at the maximum speed but may give a slightly noisier reading. See AT5600 manual 7.3 Explanation of Integration.

Select the high & low terminals to energise and measure.

Enter the limits as either

>< Min and Max wattage limits.

< Maximum wattage value

The Measure button may be used here as outlined in section 2.4.10.

Select OK. The test specification will then be displayed in the program window.

## 2.5.40. STRW - Stress Wattage

The Stress Wattage test tests the transformer for breakdown of insulation by measurement of the energizing power of a winding, usually the primary, with the remaining windings open circuit.

This test applies the voltage, usually twice the normal operating voltage, and continually measures the power to determine any breakdown by changes in the measurement.

This test is suitable for sub miniature line frequency, large line frequency bobbin wound and some HF transformers. It checks the integrity of inter-turn insulation, the magnetic material, and joints.

On selecting "STRW Stress wattage" from the available tests window, a form fill-in dialogue box will be displayed:

STRW Stress Wattage

Test Parameters

Voltage  V

Frequency  Hz

Dwell Time  sec

Terminals

High Terminal  Low Terminal

Test Limit

Maximum Power  W

Compensation

Load Compensation  W

User Offset

User Offset Enabled  W

Save Cancel

To program the test:

Enter the voltage and frequency parameters of the test signal.

Select the Dwell time you require.

Enter the names of the Hi and Lo terminals to energise and measure.

Set maximum power limit.

Select OK. The test specification will then be displayed in the program window.



### 2.5.41. LSBX - Inductance with DC1000 Bias (Series Circuit)

This test requires the use of one or more Voltech DC1000 Precision DC Bias Current Sources. Contact your Voltech sales office for details.

The inductance of a transformer winding while an external bias current is flowing through it may be tested using series or parallel equivalent circuit models. Initially the DC bias current is set up and allowed to stabilize. An AC voltage is applied across the selected winding; the voltage across and current through the winding is then measured using harmonic analysis. The measured voltage is divided by the current to obtain a complex impedance and the inductance is calculated.

On selecting 'LSBX Inductance with External Bias (Series Circuit)' from the 'Available Tests' window, a dialogue box will be displayed.

LSBX Series Inductance with Bias (DC1000)

Integration  
 Short  Medium  Long

Test Parameters  
 Signal   mV  V  mA  
 Frequency   Hz  kHz  MHz  
 Bias Current  A

Terminals  
 High Terminal  Low Terminal

Inductance Limits  
 %  >< Minimum   nH  uH  mH  H  kH  
 >  < Maximum   nH  uH  mH  H  kH

Compensation  
 Load Compensation  nH

User Offset  
 User Offset Enabled  nH

Save Measure Cancel

To program the test:

Enter the signal, frequency, and bias current (from the DC1000) required for the test.

Select the integration time you require. 'Medium' is the default setting. 'Long' will give you more stable readings (for tighter limits) at the expense of test time, and 'Short' will test at the maximum speed, but may give slightly noisier readings. See AT5600 manual 7.3 Explanation of Integration.

Enter the terminal names between which the inductance will be measured.

Select the type of limits you require and enter the values.

- % Enter a nominal value and then the +/- % limits
- >< Enter minimum and maximum values.
- > Enter just a minimum value.
- < Enter just a maximum value.

The Measure button may be used here as outlined in section 2.4.10.

Select OK. The test specification will then be displayed in the program window.

### 2.5.42. LPBX - Inductance with DC1000 Bias (Parallel Circuit)

This test requires the use of one or more Voltech DC1000 Precision DC Bias Current Sources. Contact your Voltech sales office for details.

The inductance of a transformer winding while an external bias current is flowing through it may be tested using series or parallel equivalent circuit models. Initially the DC bias current is set up and allowed to stabilize. An AC voltage is applied across the selected winding; the voltage across and current through the winding are then measured using harmonic analysis. The measured voltage is divided by the current to obtain a complex impedance and the inductance is calculated.

On selecting 'LPBX Inductance with External Bias (Parallel Circuit)' from the 'Available Tests' window, a dialogue box will be displayed.

LPBX Parallel Inductance with Bias (DC1000)

Integration  
 Short  Medium  Long

Test Parameters  
 Signal   mV  V  mA  
 Frequency   Hz  kHz  MHz  
 Bias Current  A

Terminals  
 High Terminal  Low Terminal

Inductance Limits  
 %  >< Minimum   nH  uH  mH  H  kH  
 >  < Maximum   nH  uH  mH  H  kH

Compensation  
 Load Compensation  nH

User Offset  
 User Offset Enabled  nH

Save Measure Cancel

To program the test:

Enter the signal, frequency and DC1000 bias current required for the test.

Select the integration time you require. 'Medium' is the default setting. 'Long' will give you more stable readings (for tighter limits) at the expense of test time, and 'Short' will test at the maximum speed but may give slightly noisier readings. See AT5600 manual 7.3 Explanation of Integration.

Enter the terminal names between which the inductance will be measured.

Select the type of limits you require and enter the values.

- % Enter a nominal value and then +/- % limits
- >< Enter minimum and maximum values.
- > Enter just a minimum value.
- < Enter just a maximum value.

The Measure button may be used here as outlined in section 2.4.10.

Select OK. The test specification will then be displayed in the program window.

### 2.5.43. ZBX - Impedance with DC1000 Bias

This test requires the use of one or more Voltech DC1000 Precision DC Bias Current Sources.

The Winding Impedance with External Bias test measures the impedance of a selected winding while applying a DC current from the DC1000 through the winding. An AC voltage is also applied across the winding from the AT.

This test can be used with inductors to measure the change in impedance with a bias current.

On selecting “ZBX Impedance with External Bias” from the ‘available tests’ window, the following dialog box is displayed:

**ZBX Impedance with Bias (DC1000)**

Integration  
 Short  Medium  Long

Test Parameters  
 Signal   mV  V  mA  
 Frequency   Hz  kHz  MHz  
 Bias Current  A

Terminals  
 High Terminal  Low Terminal

Impedance Limits  
 %  >< Minimum   mOhm  Ohm  kOhm  MOhm  
 >  < Maximum   mOhm  Ohm  kOhm  MOhm

Compensation  
 Load Compensation  mOhm

User Offset  
 User Offset Enabled  mOhm

Save Measure Cancel

To program the test:

Enter the value of a voltage (or current) for the signal and the required frequency of the test. Also, enter the DC1000 bias current you would like to apply.

Select the integration time required. 'Medium' is the default setting. 'Long' will give more stable readings (for tighter limits) at the expense of time, and 'Short' will test at the maximum speed but may give slightly noisier readings. See AT5600 manual 7.3 Explanation of Integration.

Enter the terminal names between which the impedance is to be measured.

Set the impedance limits.

+/- Enter a nominal value and +/- % limits.

>< Enter minimum and maximum values.

> Enter just a minimum value.

< Enter just a maximum value.

The Measure button may be used here as outlined in section 2.4.10.

Select OK. The test specification will then be displayed in the program window.

## 2.5.44. MAGX - Magnetizing Current (AC Interface)

The Magnetizing Current within a winding may be tested. An AC voltage (from an external source) is applied across the winding under test and the current flowing through the winding is measured.

This test uses an external source to provide the test signal which must be coupled to the tester via a Voltech AC Source Interface See the AC Source Interface user manual for details of how to configure external AC sources for use with an AT5600.

On selecting "MAGX Magnetizing Current (External Source)" from the available tests window, a dialog box will be displayed.

MAGX Magnetising Current (External Source)

Integration  
 Short  Medium  Long

Test Parameters  
 Voltage   mV  V  
 Frequency   Hz  kHz

Terminals  
 High Terminal  Low Terminal

Magnetising Current Limits  
 ><  < Minimum   uA  mA  A  kA  
 Maximum   uA  mA  A  kA

Compensation  
 Load Compensation  mA

User Offset  
 User Offset Enabled  mA

Save Measure Cancel

To program the test:

Enter the test voltage and frequency at which the test is to be carried out.

This is usually at the highest working voltage at the lowest operating frequency.

Select the integration time required. 'Medium' is the default setting. 'Long' will give more stable readings (for tighter limits) at the expense of an increased test time, and 'Short' will test at the maximum speed but may give a slightly noisier reading. See AT5600 manual 7.3 Explanation of Integration.

Enter the terminal names across which the voltage is to be applied and through which the magnetizing current will be measured.

Enter the expected range of magnetizing current.

>< to set Minimum and Maximum values.

< to set just maximum values

The Measure button may be used here as outlined in section 2.4.10.



### 2.5.45. VOCX - O/C Voltage ((C Interface)

The Open Circuit Voltage across a winding may be tested.

An AC voltage (from an external source) is applied across the primary winding and the resulting voltage across the chosen secondary winding is measured.

This test uses an external source to provide the test signal which must be coupled to the tester via a Voltech AC Source Interface. See the AC Source Interface user manual for details of how to configure external AC sources for use with an AT5600.

On selecting "VOCX Open Circuit Voltage (External Source)" from the available tests window, a form fill-in dialog box will be displayed:

VOCX Open Circuit Voltage (External Source)

Integration  
 Short  Medium  Long

Test Parameters  
 Voltage   mV  V  
 Frequency   Hz  kHz

Energised Terminals  
 High Terminal  Low Terminal

Measured Terminals  
 High Terminal  Low Terminal

Voltage Limits  
 %  >< Minimum   mV  V  
 >  < Maximum   mV  V

Polarity  
 +ve  -ve  No Test

Measurement  
 AC Voltage  
 DC Voltage  
 Mean sense RMS Scaled

Compensation  
 Load Compensation  mV

User Offset  
 User Offset Enabled  mV

Save Measure Cancel

To program the test:

Enter the test voltage and frequency at which the test is to be carried out.

Select one of the following: AC Voltage, DC Voltage or Mean sense, RMS scaled measurement by clicking on the relevant button.

Select the integration time required. 'Medium' is the default setting. 'Long' will give more stable readings (for tighter limits) at the expense of an increased test time, and 'Short' will test at the maximum speed but may give a slightly noisier reading. See AT5600 manual 7.3 Explanation of Integration.

Enter the terminal names for the Energized High and Low Terminals.

Similarly, enter the names for the Measured Terminals.

Set the voltage limits.

% Enter a nominal value and then the +/- % limits

>< Enter minimum and maximum values.

> Enter just a minimum value.

< Enter just a maximum value.

Polarity testing can be included in the test by selecting either positive or negative radio buttons to test against. Here the polarity test will produce either Pass or Fail results.

Note: The Measure button may be used here as outlined in section 2.4.10.

Select OK. The test specification will be displayed in the program window on the screen.

### 2.5.46. WATX - Wattage (AC Interface)

The Wattage (External Source) test measures the power needed to energize a winding, usually the primary, with the remaining windings open circuit.

It is usual to configure the test signal to the normal operating conditions of the transformer to determine the power needed to energize the transformer.

This test uses an external source to provide the test signal which must be coupled to the tester via a Voltech AC Source Interface See the AC Source Interface user manual for details of how to configure external AC sources for use with an AT5600.

See also the WATT test which uses the AT5600s internal generator which can provide up to 270V AC at 25W.

On selecting "WATX Wattage (External Source)" from the 'available tests' window, the following dialog box will be displayed.

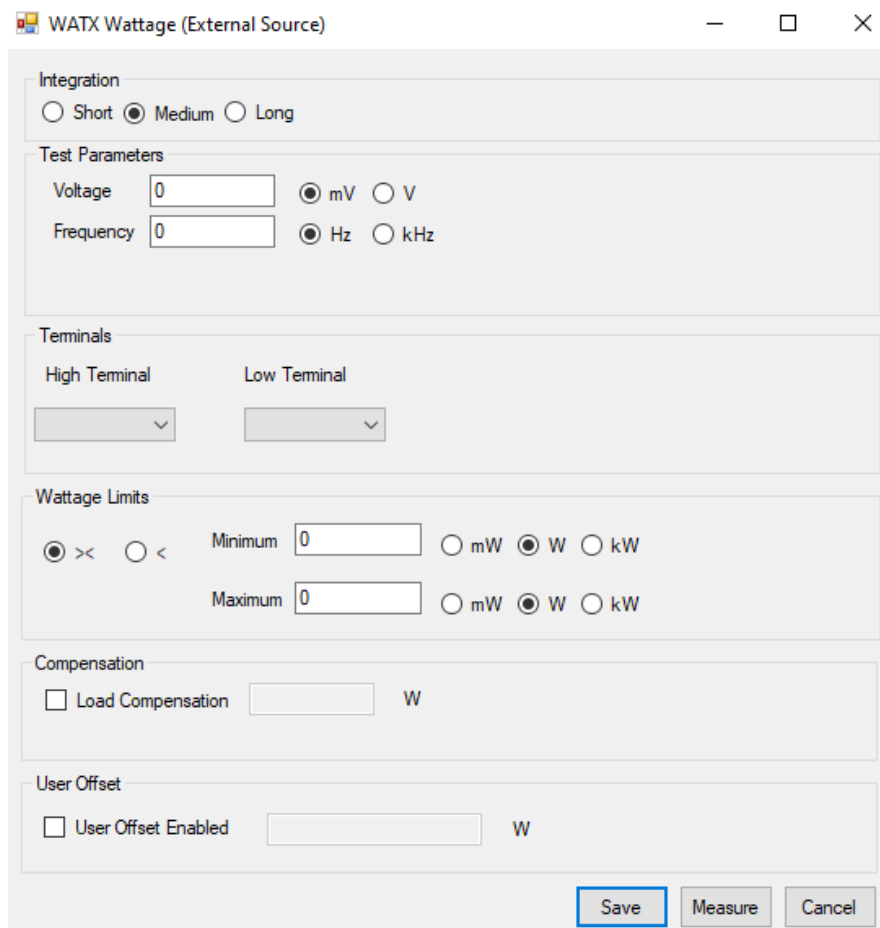

To program the test:

Enter the voltage and frequency parameters of the test signal.

Select the integration time required.

Enter the terminal names of the winding to be energized and measured.

Enter the limits for power to test against.

>< To set Minimum and Maximum values.

< To set Maximum value only.

The Measure button may be used here as outlined in section 2.4.10.

Select OK. The test specification will then be displayed in the program window.

## 2.5.47. STRX - Stress Watts (AC Interface)

The Stress Watts (External Source) test tests the transformer for breakdown of winding insulation by measurement of the energizing power of a winding, usually the primary, with the remaining windings open circuit.

This test applies the voltage from an external AC source (usually at twice the normal operating voltage and frequency), and measures the power drawn.

This test uses an external source to provide the test signal which must be coupled to the tester via a Voltech AC Source Interface. See the AC Source Interface user manual for details of how to configure external AC sources for use with an AT5600.

On selecting "STRX Stress Wattage (External Source)" from the available tests window, the following dialogue box is displayed:

STRX Stress Wattage (External Source)

Test Parameters

Voltage   mV  V

Frequency   Hz  kHz

Dwell Time  sec

Terminals

High Terminal  Low Terminal

Test Limit

Maximum Power  W

Compensation

Load Compensation  W

User Offset

User Offset Enabled  W

Save Cancel

To program the test:

Enter the voltage and frequency parameters of the test signal.

Enter the dwell time for the test signal.

Enter the terminal names of the winding to energize and measure.

Enter the Maximum power limit to test against.

Select OK. The test specification will then be displayed in the program window.

## 2.5.48. WAIT – Wait or Pause

The WAIT test can be inserted anywhere in your test program.

It can be used in two ways.

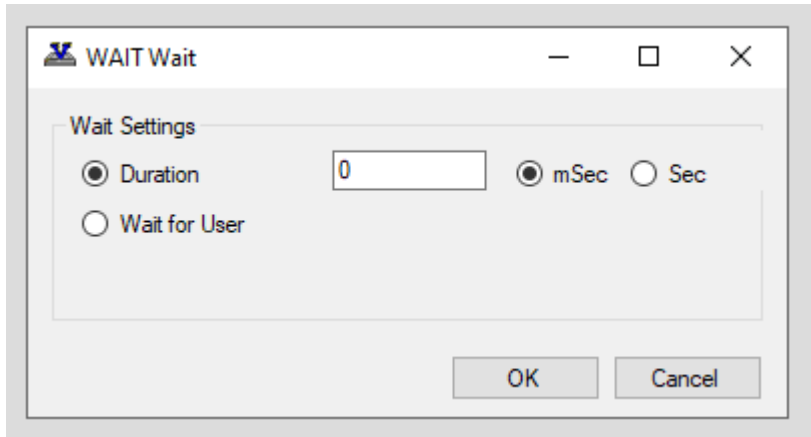

### 1, Fixed duration

Select “Duration” and enter the time you would like program to delay you would like to add.

The programmed delay can be 1 milli second to 60 Seconds.

### 2, Wait for user (indefinite pause)

This will halt all program execution until the operator presses the run button to restart the program.

During this pause all signals are turned off and the interlock is disabled, for example to fit a load resistor, without tripping the test program.

Once restarted, the interlock is reenabled as normal.

## 2.5.49. PWRF – Power Factor

The screenshot shows a software dialog box titled "PWRF Power Factor". It contains the following sections and controls:

- Integration:** Radio buttons for Short, Medium (selected), and Long.
- Test Parameters:** Input fields for Voltage (0) V and Frequency (0) Hz.
- Terminals:** Two dropdown menus for High Terminal and Low Terminal.
- Measurement:** Radio buttons for RMS (selected) and Fundamental.
- Power Factor Limits:** Radio buttons for >< (selected) and >, and input fields for Minimum (0) and Maximum (0).
- Compensation:** A checkbox for Load Compensation.
- User Offset:** A checkbox for User Offset Enabled.
- Buttons:** Save, Measure, and Cancel buttons at the bottom right.

To program the test:

Select the integration period; Short /Medium/Long as you require.

Enter the voltage (1-270V RMS) and frequency (20 Hz- 1500Hz) of the test signal.

Enter the terminal names of the winding to energize and measure.

Choose Measurement type.

RMS

Fundamental

Enter the Limit type and your test limits.

Select SAVE

The test specification will then be displayed in the program window.



## 2.6. Firmware Upgrades

The firmware of the AT5600 controls how tests are carried out, which tests are available and how the interfaces (including the front panel) function.

New versions of the firmware are made available periodically and electronic copies are available free of charge.

To maximize the performance and longevity of your AT5600, you should install these upgrades as they become available.

See the Voltech website at <http://www.voltech.com/Support/Downloads>

Upgrade firmware is distributed in a file called '11-184 ATFirmware.atfw'

Firmware upgrades should **ONLY** be done over USB, NOT RS232.

To upgrade the unit firmware.

a) Run the AT EDITOR software.

b) Connect AT EDITOR to AT5600 using a **DIRECT** USB from PC to the AT5600 USB-B port.

**DO NOT USE A USB-RS232 ADAPTER via the legacy AUX PORT.  
DISCONNECT ANY ETHERNET CONNECTION TO AT5600.**

c) On the Editor, select Tester >Download Firmware.

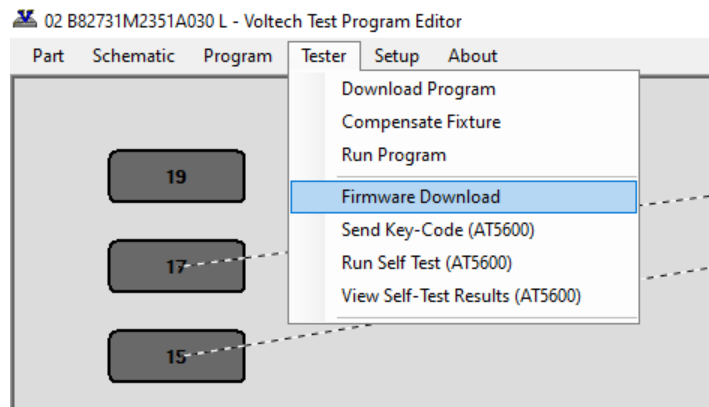

d) Locate the '11-184 ATFirmware.atfw' file you have downloaded (unzip it, first) and select it.

The firmware upgrade will now commence, and the editor screen will show a series of dialogue boxes to identify each stage in the process.

The download should take approximately 20 minutes. During the process, the unit will reboot and may appear blank; This is normal.

In the unlikely event that the editor display shows an 'ERROR' or 'FAIL' dialogue box, before the download is complete (the AT5600 screen may appear all white or all red), then WITHOUT powering-down the AT5600, try repeating the entire procedure from step (c)

Should the error persist then contact your Voltech distributor.

At the end of the download, the tester will reset itself and display the new firmware version on the front panel.

You may then carry on using your tester as normal, with the benefits offered by the new firmware being available immediately.

**WARNING:** You must NOT switch off the AT or interrupt communications during firmware updates.

## 2.7. Self-Test

The self-test is a sequence of checks made by the tester to ensure the unit is functioning correctly. It cannot check that measurements will be made to specification, but it can check that most functionality is working correctly.

Although the AT5600 will automatically detect and report most faults that may cause incorrect measurements, it is recommended to run a system test at the start of each day for added confidence that the AT5600 is operating correctly.

The self-test can also be run via the Front Panel menu.

Before commencing system test, please ensure that there is no fixture fitted and nothing is touching any of the test nodes on the top surface of the AT5600. The self-test shall only run if the Safety Interlock is in the safe condition.

**CAUTION:** If the connections have been correctly made to the Safety Interlock, safe condition, then high voltage, generating up to 7000V, shall be present on all the test nodes on the top surface of the AT5600.

To run the Self-Test;

a) Run the AT EDITOR software.

b) Connect AT EDITOR using USB (preferred) or RS232 comms to the AT5600.

c) On the Editor, select Tester >Run Self-Test.

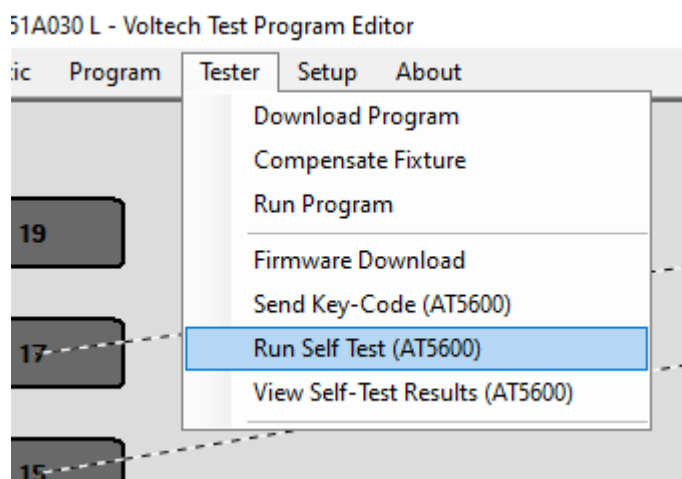

d) The self-test shall start, and a progress prompt shall appear on the screen.

d) At the 'Save As' prompt, assign a name for the file which the results will be saved to, in the example below, the file name is set to 1234.xml, then click Save.

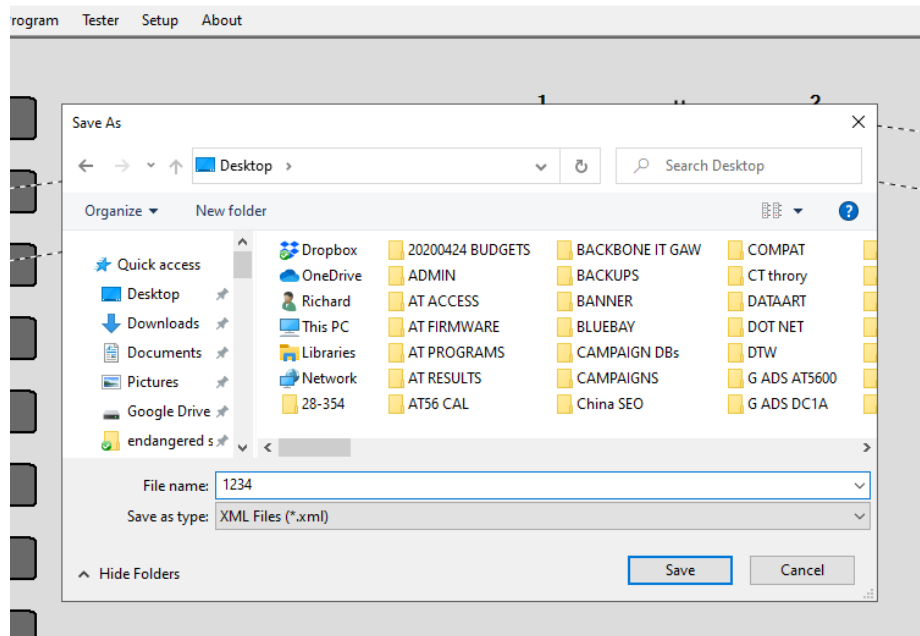

f) A prompt shall be displayed when the Self-Test is complete

g) If the self-test detects a failure, a Self-Test Fail shall pop-up, contact your Voltech supplier for service.

Please include the self-test log file, SelfTest.xml, with your inquiry for service.

## 2.8. Customize Tester

The Customize Tester feature in the AT Editor software shall be used to unlock newly purchased tests or to apply 30-day demo codes.

To determine which test are available on a specific unit use the front panel to navigate to **Set Up > Unit Information > Test List**

Contact your Voltech sales office to purchase or demo trial any tests that are not available.

To upgrade the AT5600 with new tests.

- a) Run the AT EDITOR software.
- b) Connect AT EDITOR using USB (preferred) or RS232 comms to the AT5600.
- c) On the Editor, select **Tester >Send Key-Code**.

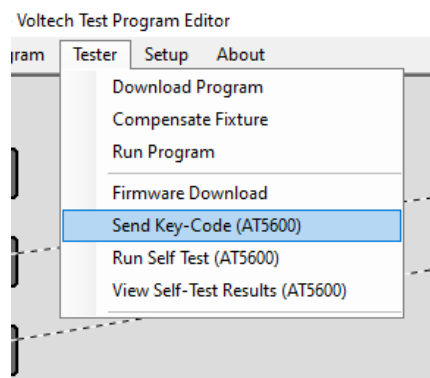

- d) The following pop-up window shall appear.

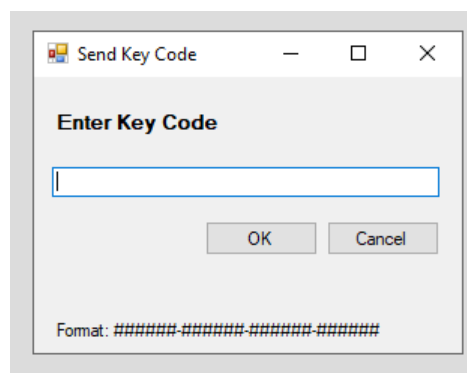

- e) Enter the new Key-code and then click OK



## 3. Change Log

Please find below change history for this user manual and AT Editor.

Both these items are free to download from our website, free of charge, for all users.

Voltech Instruments are committed to a policy of continuous product improvement and development. Hence, product specification and the information given in this manual are subject to change.

Below will give an overview of improvements, new features, and corrections.

### 3.1. AT Editor dotNET software

Updates and change log are now published online at

<https://www.voltech.com/support/at5600-support-home/at-editor-and-server-updates/>

## 3.2. AT Editor dotNET manual

V4	1.1.1 added auto programming
v3	clarity on allowed character for file name 2.4.13  ACRT DCRT ACVB DCVB test withdrawn, and no longer supported.  2.4.13.2 and 2.4.13.3 updated best practice advice for ORDER and Grouping of test types to get best speed, accuracy and to minimize damage to the unit.
v2	Updated 2.4.14 for File name / Prog name Diff and Legacy features on report.
v1	Initial Release

© 2020 Voltech Instruments All rights reserved.

No part of this publication may be produced, stored in a retrieval system, or transmitted in any form, or by means, electronic, mechanical photocopying, recording or otherwise without prior written permission of Voltech.